



Mobile Panel

User's Manual

Version: **1.5 (Jan. 2005)**

Model No.: **5MAMPX.0001-EN**

We reserve the right to change the contents of this manual without warning. The information contained herein is believed to be accurate as of the date of publication; however, Bernecker + Rainer Industrie-Elektronik Ges.m.b.H. makes no warranty, expressed or implied, with regards to the products or the documentation contained within this book. In addition, Bernecker + Rainer Industrie-Elektronik Ges.m.b.H. shall not be liable in the event of incidental or consequential damages in connection with or resulting from the furnishing, performance, or use of these products. The software names, hardware names, and trademarks contained in this document are registered by the respective companies.





Chapter 1: General information

Chapter 2: Technical Data

Chapter 3: Start-up / Operation

Chapter 4: Software

Chapter 5: Standards and Certifications

Chapter 6: Accessories



Chapter 7: Maintenance / Servicing

Appendix A: Data

Figure Index

Table Index

Index

Model Number Index



Chapter 1: General Information	11
1. Manual History	11
2. Safety Notices	13
3. Guidelines	13
4. Safety Regulations	13
4.1 Introduction	13
4.2 Intended Use	14
4.3 Transport and Storage	14
4.4 Mounting	14
4.5 Operation	15
4.5.1 Supply Voltage	15
4.5.2 E-stop System	16
4.5.3 Enable Switch	16
5. Model Numbers	18
5.1 Operating Unit	18
5.2 Handle	18
5.3 Connection Cable	18
5.4 Switching Cabinet Cable	19
5.5 Wall Mount	19
5.6 Strapping Plug	19
5.7 Accessories	20
5.8 Software	20
 Chapter 2: Technical Data	 21
1. Introduction	21
1.1 Features	22
1.2 Construction	23
2. Entire Device	24
2.1 Dimensions	24
2.2 Technical Data	25
3. Individual Components	27
3.1 Operating Unit	27
3.1.1 Dimensions	28
3.1.2 Mylar Keypad	28
3.1.3 Entry Devices	29
3.1.4 Touch Screen Pen	30
3.1.5 CF / USB Cover	30
3.1.6 Rear View of an Operating Unit	35
3.1.7 Switches, Buttons and Batteries	36
3.1.8 Technical Data	39
3.2 Handle	59
3.2.1 Dimensions	60
3.2.2 Technical Data	60
3.2.3 Enable Switch	60
3.2.4 Operating Unit Fastener	62
3.2.5 Fastening the Connection Cable	63

Table of Contents

3.3 Connection Cable	64
3.3.1 Technical Data	65
3.3.2 Cable Specifications	66
3.4 Switching Cabinet Cable Crossover	68
3.4.1 Shielding in the Switching Cabinet	68
3.4.2 Technical Data	69
3.4.3 Cable Specifications	70
3.4.4 Drilling Template for the Connection Housing	71
3.5 Switching Cabinet Cable - Straight Through	73
3.5.1 Shielding in the Switching Cabinet	73
3.5.2 Technical Data	74
3.5.3 Cable Specifications	75
3.5.4 Drilling Template for the Connection Housing	76
3.6 Wall Mount	77
3.6.1 Technical Data	78
3.6.2 Dimensions	79
3.6.3 Storing the Mobile Panel Device	80
3.7 Strapping Plug	81
3.7.1 Order Data	81
3.7.2 Technical Data	81
3.7.3 Cable Layout	82

Chapter 3: Start-up / Operation 83

1. Commissioning from a Safety Point of View	83
1.1 Intended Use	83
2. Operating the Mobile Panel Device	84
3. Recommended Monitoring Devices	85
3.1 Connection Examples for the E-stop and Key Switch	86
3.1.1 Connection Example for Safety Circuits up to EN 954-1 Category 4	86
3.1.2 Connection Example for Safety Circuits up to EN 954-1 Category 1	88
3.2 Connection Example for the Enable Switch	90
3.2.1 Connection Example for Safety Circuits up to EN 954-1 Category 4	90
3.3 Current Load of the Enable Switch and Entry Device Circuit	92

Chapter 4: Software 93

1. Mobile Panel with Automation Runtime	93
1.1 General Information	93
1.2 Control and Visualization with the Mobile Panel	94
1.3 Operation and Monitoring with the Mobile Panel	95
1.4 Summary Screen	95
2. Mobile Panel with Windows CE	97
2.1 General Information	97
2.2 Requirements	97
2.3 Installation	97
2.4 Serial ActiveSync Connection	98
2.5 Mobile Panel as a Thin Client	99

3. Mobile Panel with Windows XP Embedded	100
3.1 General Information	100
3.2 Requirements	100
3.3 Installation Procedures	100

Chapter 5: Standards and Certifications 101

1. Valid European Guidelines	101
2. Overview of Standards	101
3. Requirements for Emissions (Emission)	103
3.1 Network Related Emissions	103
3.2 Electromagnetic Emissions	104
4. Requirements for Immunity to Disturbances (Immunity)	105
4.1 Electrostatic Discharge (ESD)	106
4.2 High-frequency Electromagnetic Fields (HF field)	106
4.3 High-speed Transient Electrical Disturbances (Burst)	107
4.4 Surge Voltages (Surge)	107
4.5 Conducted Disturbances	107
4.6 Magnetic fields with energy technical frequencies	108
4.7 Voltage dips, fluctuations and short-term interruptions	108
4.8 Damped Oscillations	109
5. Mechanical Conditions	110
5.1 Vibration Operation	110
5.2 Vibration Transport	110
5.3 Shock Operation	111
5.4 Shock Transport (packed)	111
5.5 Toppling	111
5.6 Free Fall (packed)	112
6. Climate Conditions	112
6.1 Worst Case Operation	113
6.2 Dry Heat	113
6.3 Dry Cold	113
6.4 Large Temperature Fluctuations	113
6.5 Temperature Fluctuations in Operation	114
6.6 Humid Heat, Cyclical	114
6.7 Humid Heat, Constant (storage)	114
7. Further Limit Values	114
8. International Certifications	116
8.1 BGFE Certificate	116
9. Standards and Definitions for Safety Technology	117

Chapter 6: Accessories 121

1. Overview	121
2. Replacement CMOS Batteries	122
2.1 Order Data	122
2.2 Technical Data	122
3. Touch Screen Pen	123

Table of Contents

3.1 Order Data	123
4. Compact Flash cards 5CFCRD.xxxx-02	124
4.1 General Information	124
4.2 Order Data	124
4.3 Technical Data	124
4.4 Dimensions	125
4.5 Calculating the Lifespan	126
5. USB Memory Stick	132
5.1 General Information	132
5.2 Order Data	132
5.3 Technical Data	132

Chapter 7: Maintenance / Servicing 135

1. Cleaning	135
2. Exchanging the Connection Cable	136
2.1 Procedure	136
3. Changing the Battery	141
3.1 Procedure	141

Appendix A: 145

1. E-stop button	145
2. Key Switch	146
3. Enable Switch	147
4. Touch Screen	148
4.1 3M Touch	148
4.1.1 Cleaning	149
4.2 Gunze Touch	149
4.2.1 Cleaning	150
5. Mylar	150
6. Filter Glass	152
6.1 Mechanical Characteristics	152
6.2 Chemical Properties	152
7. Housing	152

Chapter 1 • General Information

Information:

B&R does its best to keep the printed versions of its user's manuals as current as possible. However, sometimes a newer version of the user's manual can be downloaded in electronic form (pdf) from the B&R homepage www.br-automation.com.

1. Manual History

Version	Date	Comment
1.0	16.03.2004	First edition, created with BuR HB manual template V33_09_2003
1.1	17.09.2004	Changes / New Features <ul style="list-style-type: none"> - New image for "Automation Runtime summary screen", on page 96 and corresponding description in the table "Automation Runtime summary screen", on page 96. - New image for "Wall Mount 4MPBRA.0000-00", on page 77. - Section for wall mount installation of the Mobile Panel using 4MPBRA.0000-00 added (see section "Storing the Mobile Panel Device", on page 80). - Replacement touch screen pen added, see section "Touch Screen Pen", on page 123. - Section "Recommended Monitoring Devices", on page 85 updated - Note regarding unwanted safety category 4 according to EN 954-1 was added. - Section "Switching Cabinet Cable - Straight Through", on page 73 (5CAMPC.0020-01) added. - Chapter 5 "Standards and Certifications" updated. - Safety-related texts matched to the current BGFE guidelines. - Section "Current Load of the Enable Switch and Entry Device Circuit", on page 92 added. - Section "Features", on page 22 for Mobile Panel devices updated. - Section "Entire Device", on page 24 updated. - Figure "Dimensions for the entire device", on page 24 added. - "Appendix A" updated. - Section "Compact Flash cards 5CFCRD.xxxx-02", on page 124 updated. - Technical data for all operator panels was expanded.

Table 1: Manual history

Version	Date	Comment
1.1	17.09.2004	<ul style="list-style-type: none"> - 2 GB Compact Flash card (5CFCRD.2048-02) added. - Length tolerance values for connection and switching cabinet cables added. - Connection and switching cabinet cable weight values per meter added. - USB memory sticks (5MMUSB.0128-00, 5MMUSB.0256-00, 5MMUSB.0512-00) added. - New "Connection Example for the Enable Switch", on page 90 with new monitoring device. - Connection example for E-stop and key switch added for "Category 3 according to EN 954-1", on page 86. - Connection example for E-stop and key switch added for "Category 2 according to EN 954-1", on page 87. - Connection example for E-stop and key switch added for "Connection example for safety circuits up to category 1 according to EN 954-1", on page 85. - Connection example for E-stop and key switch added for "Category B according to EN 954-1", on page 91. - Connection example for enable switch added for "Category 3, 2, 1 and B according to EN 954-1", on page 94. - 7 meter long Mobile Panel connection cable (5CAMPH.0070-00) added. - Application example for the Mobile Panel with Automation Runtime expanded (see section "Control and Visualization with the Mobile Panel", on page 94 or section "Operation and Monitoring with the Mobile Panel", on page 95). - Application example for the Mobile Panel with BIOS expanded (see section "Mobile Panel as a Thin Client", on page 99). - Model numbers for Windows CE added (see section 5.8 "Software" on page 20). - Shock and vibration values added to the general device data. - Section 2.4 "Serial ActiveSync Connection" on page 98 (cable specifications) added. - Windows XP Embedded section added. - SanDisk White Paper added for calculating Compact Flash lifespan. - Mobile Panel labeling sticker added (see "Type Plate", on page 36).
1.2	18.10.2004	<p>Changes / New Features</p> <ul style="list-style-type: none"> - New notes for the device components listed in Appendix A. - Section 3.1.7 "Switches, Buttons and Batteries" moved to chapter 2 "Technical Data". - Description for the mode/node switch settings for the Mobile Panel with BIOS updated (see table 16 "BIOS switch settings for the mode / node switch"). - Information for securing the enable switch and entry device circuit added (see page 92).
1.3	22.10.2004	<p>Changes / New Features</p> <ul style="list-style-type: none"> - Standard overview changed: EN418 added, PSA guidelines removed. - Existing note for the limited enable function on the controller-side that is time or program step dependent is defined as warning (see section 4.5.3 "Enable Switch" on page 16).
1.4	28.10.2004	<p>Changes / New Features</p> <ul style="list-style-type: none"> - Correction of E-stop button properties to pre-emption. - Text changed in "General Information" section for the type plate. - Chapter 3 Start-up / Operation updated (e.g. removal of safety circuits). - Text changed in Chapter 5 Standards and Certifications - section Standards and Definitions for Safety Technology - footnote 1.
1.5	29.10.2004	<p>Changes / New Features</p> <ul style="list-style-type: none"> - Correction of the maximum current load limit for the enable switch circuit from 0.5 to 0.4 A. - Fuse type for protecting the E-stop circuit and enable switch circuit changed from 0.5 to 0.4 A. - Text changes concerning using the PNOZ e2.1p as monitoring device for the enable switch made on page 85.

Table 1: Manual history (cont.)

2. Safety Notices

The safety notices in this manual are organized as follows:

Safety notices	Description
Danger!	Disregarding the safety regulations and guidelines can be life-threatening.
Caution!	Disregarding the safety regulations and guidelines can result in severe injury or major damage to material.
Warning!	Disregarding the safety regulations and guidelines can result in injury or damage to material.
Information:	Important information for preventing errors

Table 2: Safety guidelines

3. Guidelines

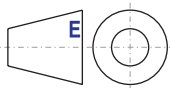

All dimension diagrams (e.g. dimension diagrams, etc.) are drawn according to European dimension standards.

4. Safety Regulations

Information:

The instructions listed, which refer to the wiring and devices used to ensure safety, must be precisely followed in all cases. Otherwise sources of danger can arise, which could cause the integrated safety equipment in the Mobile Panel to be bypassed.

Danger!

The corresponding safety guidelines for safety and accident regulations must also be reviewed for the respective situation in addition to and independent of this document.

4.1 Introduction

Programmable logic controllers (PLCs), operating and monitoring devices (industrial PCs, Power Panels, Mobile Panels, etc.) as well as the B&R uninterruptible power supplies have been designed, developed or manufactured for conventional use in industry. They were not designed, developed and manufactured for any use involving serious risks or hazards that could lead to death, injury, serious physical damage or loss of any kind without the implementation of exceptionally stringent safety precautions. In particular, such risks and hazards include the use of these devices to monitor nuclear reactions in nuclear power plants, as well as flight control

systems, flight safety, the control of mass transportation systems, medical life support systems, and the control of weapons systems.

The safety precautions applying to industrial control systems (e.g. the provision of safety devices such as emergency stop circuits, etc.) in accordance with applicable national and international regulations must be observed both when using programmable logic controllers and when using operating and monitoring devices as control systems in conjunction with a Soft PLC (e.g. B&R Automation Runtime or comparable products) or a Slot PLC (e.g. B&R LS251 or comparable products). The same applies for all other devices connected to the system, such as drives.

All tasks such as installation, commissioning and service may only be carried out by qualified personnel. Qualified personnel are persons who are familiar with the transport, mounting, installation, commissioning and operation of the product and have the appropriate qualifications (e.g. IEC 60364). National accident prevention guidelines must be followed.

The safety guidelines, connection descriptions (rating plate and documentation) and limit values listed in the technical data must be read carefully before installation and commissioning and must be observed.

4.2 Intended Use

Electronic devices are generally not fail-safe. In the event of a failure on the programmable control system, operating or monitoring device or uninterruptible power supply, the user is responsible for ensuring that other devices that may be connected, such as motors, are made safe.

4.3 Transport and Storage

During transport and storage, devices must be protected from excessive stress (mechanical load, temperature, humidity, aggressive atmosphere).

4.4 Mounting

- The installation must take place according to the documentation using suitable equipment and tools.
- The devices are only allowed to be installed without voltage applied and by qualified personnel.
- General safety regulations and nationally applicable accident prevention guidelines must be observed.
- Electrical installation must be carried out according to the relevant guidelines (e.g. line cross section, fuse, protective ground connection).

4.5 Operation

Warning!

- When operating a system with the Mobile Panel, take note that at this point in time operation is only possible using the Mobile Panel and is not possible from any other point in the system.
- If the safety equipment (safety door, etc.) is not active, the movements carried out using the Mobile Panel are only permitted when the enable switch is activated and at reduced speed.

Danger!

When using an E-stop circuit according to EN 954-1, the function of the E-stop circuit must be checked at least monthly.

4.5.1 Supply Voltage

Caution!

- The 24 VDC supply must be separated from the low voltage signals in a secure manner to provide protection from dangerous voltages. This can be done, for example, using a safety transformer or similar equipment.
- When dimensioning the supply, the voltage drop on the Mobile Panel connection cable and switching cabinet cable must be taken into consideration.
- The supply circuit must be protected using a 3 A (slow-blow) fuse.

Warning!

- The project engineer for a machine or system must make provisions to guarantee that an interrupted program is started again properly after voltage drops and power failures. Not even short-term operating states that cause dangerous situations are permitted to occur.
- Errors that occur on automation systems can cause injury and damage to material, therefore additional measures must be taken to ensure safe operation of the entire system should errors occur.
- The functionality of the safety-relevant equipment (e.g. E-stop and enable switch) must be monitored cyclically.
- After heavy loads, e.g. shock to the device or dropping the device, the safety-relevant equipment must be checked.

4.5.2 E-stop System

The E-stop safety equipment found on the Mobile Panel meets EN418 requirements and can be used together with a corresponding monitoring system for safety-relevant control tasks (up to category 4 according to EN 954-1).

Danger!

- **When unplugged, the Mobile Panel must be kept away from sources of danger on the machine or system and must be locked away. An E-stop that is not connected must be kept out of sight for the user because the closest E-stop will be pressed if a dangerous situation occurs and, when unplugged, this E-stop does not function.**
- **The E-stop must be effective in any operating mode on the machine or system.**
- **Deactivating the E-stop is not permitted to cause an automatic restart.**
- **The E-stop is not a replacement for safety equipment.**
- **If the machine or system was brought to a standstill using the E-stop button, the E-stop button is only to be deactivated and the system being monitored is only to be restarted after the reason for stopping has been corrected and the dangerous situation no longer exists.**

Caution!

Dropping the Mobile Panel can trigger the E-stop button and cause the system being monitored to come to a standstill.

Connection examples for the E-stop button and the key switch for various categories (EN 954-1) can be found in chapter 3 "Start-up / Operation", section "Connection Examples for the E-stop and Key Switch", on page 86.

4.5.3 Enable Switch

The enabling equipment consists of the enable button as seen in figure 23 "Handle 4MPHDL.0000-00" on page 59 and is part of the Mobile Panel safety equipment.

Obtaining safety category 4 according to EN 954-1 is possible through the implementation of enabling equipment with 2-circuits and using a corresponding monitoring device.

The enabling functionality is described in EN60204. The 3-step enable switch is state-of-the-art technology. The "Null" and "Panic" positions on the enable switch represent off functions. Only the "Enable" position allows activation. The standards EN60204 and IEC60204-1 are identical, which provides the 3-step enabling switch with international significance.

Warning!

When applicable, the enable function should be limited on the controller according to time or program step.

The electromechanical enable switch and equipment are to be linked with the controller so that the safety-related circuit requirements are met according to DIN EN 775, DIN EN 60204-1, DIN EN 954-1, DIN EN 1088 and VDI 2854.

The cables and lines used to set up the system (except for protective ground conductors) that can be accessed or are open to other conductive parts without opening or removing a cover must either have double or reinforced insulation between wires and the surface or have a metal sheath that can handle the current if a short-circuit occurs between the wire and sheath.

Warning!

- **The enable switch is only suitable as a protective function if the person activating the enable switch can recognize the danger in time and immediately take action to prevent the dangerous situation!**
- **Commands for dangerous states are not permitted to be initiated by the enable switch alone. A second conscious start command is required here. The only person permitted in the danger area is the person activating the enable switch.**

An enable switch connection example for a monitoring device can be found in chapter 3 "Start-up / Operation", section 3.2 "Connection Example for the Enable Switch" on page 90.

5. Model Numbers

5.1 Operating Unit

Model Number	Description	Note
4MP181.0843-03	MP181 TFT C VGA 8.4in FT Operating unit with 8.4" VGA color LCD with Touch Screen (resistive); 19 system keys; 64 MB SDRAM; Compact Flash Slot (type I); ETH10/100; RS232 (Rx/D, Tx/D); USB; E-stop; key switch; IP54 protection (only with handle 4MPHDL.0000-00).	
4MP251.0571-12	MP251 LCD C QVGA 5.7in F Operating unit with 5.7in QVGA color LCD; 14 softkeys and 19 system keys; 64 MB SDRAM; Compact Flash Slot (type I); ETH10/100; RS232 (Rx/D, Tx/D); CAN; USB; E-stop; key switch; IP54 protection (only with handle 4MPHDL.0000-00).	
4MP281.0571-12	MP281 LCD C QVGA 5.7in FT Operating unit with 5.7in QVGA color LCD with touch screen (resistive); 14 softkeys and 19 system keys; 64 MB SDRAM; Compact Flash Slot (type I); ETH10/100; RS232 (Rx/D, Tx/D); CAN; USB; E-stop; key switch; IP54 protection (only with handle 4MPHDL.0000-00).	
4MP281.0843-13	MP281 TFT C VGA 8.4in FT Operating unit with 8.4in VGA color LCD with touch screen (resistive); 19 system keys; 64 MB SDRAM; Compact Flash Slot (type I); ETH10/100; RS232 (Rx/D, Tx/D); CAN; USB; E-stop; key switch; IP54 protection (only with handle 4MPHDL.0000-00).	
5MP181.0843-07	MP181 TFT C VGA 8.4in FT Operating unit with 8.4in VGA color LCD with touch screen (resistive); 19 system keys; 128 MB SDRAM; Compact Flash Slot (type I); ETH10/100; RS232 (Rx/D, Tx/D); CAN; USB; E-stop; key switch; IP54 protection (only with handle 4MPHDL.0000-00).	

Table 3: Model numbers for Mobile Panel operating unit

5.2 Handle

Model Number	Description	Note
4MPHDL.0000-00	Mobile Panel handle Mobile Panel handle with integrated three-step enable switch.	

Table 4: Model number for Mobile Panel handle

5.3 Connection Cable

Model Number	Description	Note
5CAMPH.0050-00	Mobile Panel connection cable 5 m¹⁾ Mobile Panel connection cable 5 meters long; with plug contacts for cabling the Mobile Panel incl. an industrial connector for the switching cabinet cable.	
5CAMPH.0070-00	Mobile Panel connection cable 7 m¹⁾ Mobile Panel connection cable 7 meters long; with plug contacts for cabling the Mobile Panel incl. an industrial connector for the switching cabinet cable.	
5CAMPH.0100-00	Mobile Panel connection cable 10 m¹⁾ Mobile Panel connection cable 10 meters long; with plug contacts for cabling the Mobile Panel incl. an industrial connector for the switching cabinet cable.	

Table 5: Model numbers for Mobile Panel connection cables

Model Number	Description	Note
5CAMPH.0150-00	Mobile Panel connection cable 15 m¹⁾ Mobile Panel connection cable 15 meters long; with plug contacts for cabling the Mobile Panel incl. an industrial connector for the switching cabinet cable.	
5CAMPH.0200-00	Mobile Panel connection cable 20 m¹⁾ Mobile Panel connection cable 20 meters long; with plug contacts for cabling the Mobile Panel incl. an industrial connector for the switching cabinet cable.	

Table 5: Model numbers for Mobile Panel connection cables (cont.)

1) Proper operation of the serial interface is only guaranteed up to a total cable length of 15 meters (connection cable + switching cabinet cable + application-specific cables).

5.4 Switching Cabinet Cable

Model Number	Description	Note
5CAMP.0020-00	Switching cabinet cable - crossover 2 m¹⁾ Switching cabinet cable 2 meters long; with wire tip sleeves for connection in the switching cabinet incl. installation socket for the Mobile Panel connection cable.	
5CAMP.0020-01	Switching cabinet cable - straight through 2 m¹⁾ Switching cabinet cable 2 meters long; with wire tip sleeves for connection in the switching cabinet incl. installation socket for the Mobile Panel connection cable.	

Table 6: Model numbers for Mobile Panel switching cabinet cables

1) Proper operation of the serial interface is only guaranteed up to a total cable length of 15 meters (connection cable + switching cabinet cable + application-specific cables).

5.5 Wall Mount

Model Number	Description	Note
4MPBRA.0000-00	Wall mount with cable supports Wall mount for storing the Mobile Panel; with supports for the Mobile Panel connection cable	

Table 7: Model number for Mobile Panel wall mount

5.6 Strapping Plug

Model Number	Description	Note
4MPBYP.0000-00	Strapping plug Used to bridge the E-stop contacts on the switching cabinet socket of the Mobile Panel switching cabinet cable.	

Table 8: Model number for Mobile Panel strapping plug

5.7 Accessories

Model Number	Description	Note
0AC201.9	Lithium batteries (5x) Lithium batteries, 5 pcs., 3 V / 950 mAh, button cell	
4A0006.00-000	Lithium battery (1x) Lithium battery, 1 piece, 3 V / 950 mAh, button cell	
5AC900.1100-00	Touch screen pen (5x) Five replacement touch screen pens	
5CFCRD.0032-02	Compact Flash 32 MB TruEIDE SanDisk/A Compact Flash card with 32 MB Flash PROM, and true IDE/ATA interface.	
5CFCRD.0064-02	Compact Flash 64 MB TruEIDE SanDisk/A Compact Flash card with 64 MB Flash PROM, and true IDE/ATA interface.	
5CFCRD.0128-02	Compact Flash 128 MB TruEIDE SanDisk/A Compact Flash card with 128 MB Flash PROM, and true IDE/ATA interface	
5CFCRD.0256-02	Compact Flash 256 MB TruEIDE SanDisk/A Compact Flash card with 256 MB Flash PROM, and true IDE/ATA interface	
5CFCRD.0512-02	Compact Flash 512 MB TruEIDE SanDisk/A Compact Flash card with 512 MB Flash PROM, and true IDE/ATA interface	
5CFCRD.1024-02	Compact Flash 1024 MB TruEIDE SanDisk/A Compact Flash card with 1024 MB Flash PROM, and true IDE/ATA interface	
5CFCRD.2048-02	Compact Flash 2048 MB TruEIDE SanDisk/A Compact Flash card with 2048 MB Flash PROM, and true IDE/ATA interface	
5MMUSB.0128-00	USB memory stick 128 MB SanDisk USB 2.0 Memory Stick 128 MB	
5MMUSB.0256-00	USB memory stick 256 MB SanDisk USB 2.0 Memory Stick 256 MB	
5MMUSB.0512-00	USB memory stick 512 MB SanDisk USB 2.0 Memory Stick 512 MB	

Table 9: Model numbers for accessories

5.8 Software

Model Number	Description	Note
9S0001.13-010	OEM MS-WinCE4.1 German OEM Microsoft Windows CE 4.1 German license, only supplied together with a Mobile Panel BIOS device.	
9S0001.13-020	OEM MS-WinCE4.1 English OEM Microsoft Windows CE 4.1 English license, only supplied together with a Mobile Panel BIOS device.	
9S0001.17-020	OEM MS-WinCE4.2 English OEM Microsoft Windows CE 4.2 English license, only supplied together with a Mobile Panel BIOS device.	
9S0001.21-020	OEM MS-WinXPe MP100/200 w/CF English Only delivered with a Mobile Panel BIOS device!	

Table 10: Model numbers for Mobile Panel software

Chapter 2 • Technical Data

1. Introduction

The Mobile Panel is a portable operating, display and control device that can be used anywhere where machine operation and monitoring require the maximum amount of flexibility. This Mobile Panel advantage is evident for example in the areas of material handling, robotics, tools or special machines, etc.

The machine operator is always near the machine, allowing him to have a direct influence on the current process.

Depending on the variation, Mobile Panel devices have a 5.7" QVGA color display with or without touch screen or an 8.4" VGA color display with touch screen. In addition, Mobile Panel devices have a Mylar keypad (numeric and alphanumeric keys). Integrated safety functions consist of a three-step enable switch (2-channel) and an E-stop button (2-channel). It is operated using the Mylar keypad and the touch screen (with a touch screen pen).



Figure 1: Mobile Panel

Depending on the design, Mobile Panel devices are delivered with the operating system Automation Runtime (AR) or with a BIOS.

The AR devices are programmed uniformly into the entire B&R automation system with B&R Automation Studio (Visual Components).

1.1 Features

- Processor 266 MHz, MMX compatible
- 5.7" QVGA or 8.4" VGA display ¹⁾
- Compact Flash card (type I) ²⁾
- USB 1.1 Connection ²⁾
- 24 VDC supply voltage
- Ethernet 10/100 MBit interface
- RS232 interface (RxD, TxD), not modem-capable
- CAN interface¹⁾
- 2 operating mode switches (2 x 16 digit)
- Touch screen (analog resistive)
- Filter glass (multiple coated non-reflective)¹⁾
- Mylar keypad
- Fan free operation
- Automation Runtime or BIOS ¹⁾
- Real-time clock (battery-buffered)¹⁾
- Up to 128 MB SDRAM main memory¹⁾
- Integrated E-stop button and key switch
- Touch screen pen (only on touch screen devices)
- IP54 protection (with handle)
- Left and right hand operation
- Amount handle can be turned in relation to the operating unit: $\pm 45^\circ$ from the middle position

1) Depending on the design of the Mobile Panel device version.

2) Can be accessed from behind the CF USB cover on the front of the Mobile Panel's operator panel.

1.2 Construction

Mobile Panel devices are cable connected; i.e. they are connected with the switching cabinet using a cable. For operation, the following individual components are needed:

- Operating unit
- Handle
- Connection cable
- Switching cabinet cable



Figure 2: Mobile Panel device design

An optional wall mount is available for storing all connection cables during stationary operation of the system for the Mobile Panel device (for more see Section 3.6 "Wall Mount" on Page 77).

2. Entire Device

2.1 Dimensions

The dimensions of the 5.7" and 8.4" display versions for the Mobile Panel devices are the same.

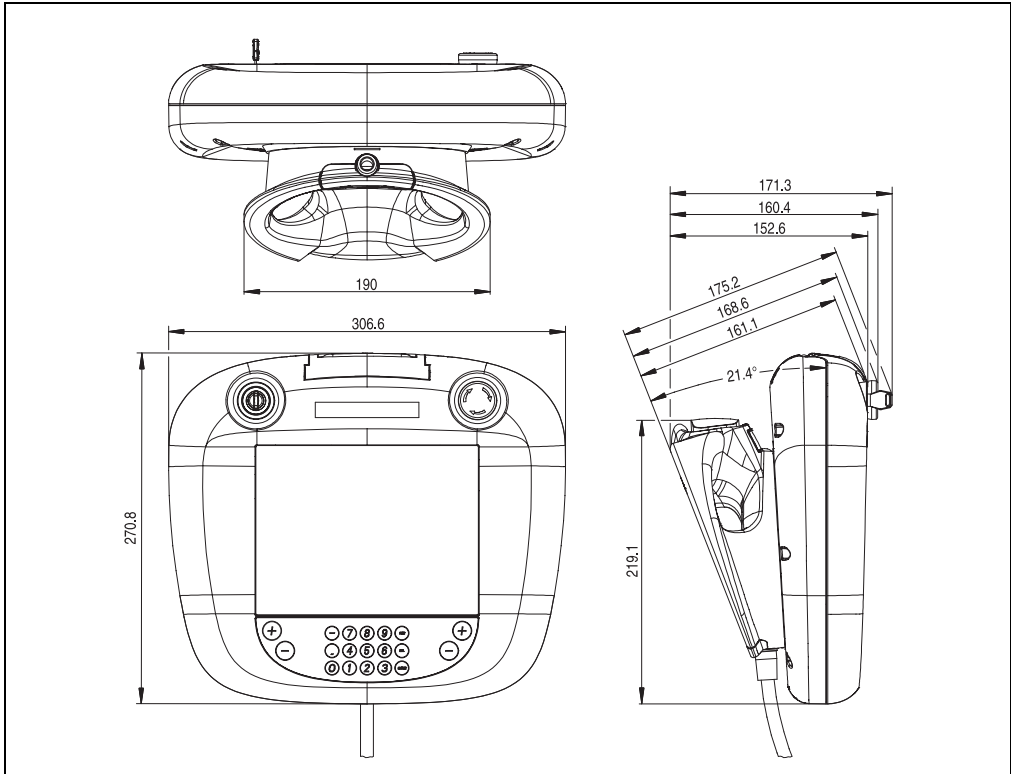

Figure 3: Dimensions for the entire device

2.2 Technical Data

Features	5.7" Display Versions	8.4" Display Versions
Power Supply Rated Voltage Starting Current Power Input Electrical Isolation	24 VDC ± 25% for short time (approx. 1 ms) 20 A Approx. 8 Watt typically, max. 10 Watt	
Safety Elements / Entry Devices E-stop Button Key Switch Enable Switch Current Load	2 N.C., right position in the operating unit 1 N.O., left position in the operating unit 3-step, 2-channel, front position on the handle See Section "Current Load of the Enable Switch and Entry Device Circuit", on page 92	
Mechanics		
Operating Unit Material Paint, Color	Double-walled housing from plastic (Cycoloy C2950) Soft-touch coating, similar RAL7016	
Handle Material Paint, Color	Plastic (pure compact foam) Soft-touch coating, similar RAL7016	
Outer Dimensions in mm (WxHxD) Without Handle With Handle	306.6 x 76 x 270.8 306.6 x 152.6 x 270.8	
Weight (without handle, Compact Flash card and connection cable) (without handle, Compact Flash card, without connection cable)	1650 grams 2210 grams	1900 grams 2460 grams
Environment¹⁾		
Environmental Temperature Operation Storage Transport	0 °C to 45 °C -20 °C to +60° C -20 °C to +60° C	0 °C to 45 °C -20 °C to +70 °C -20 °C to +70 °C
Humidity Operation Storage Transport	45 % to 85 %, non-condensing 8 % to 85 %, non-condensing 8 % to 85 %, non-condensing	
Vibration Operation (continuous) Operation (occasional) Storage Transport	Max. 9 - 200 Hz and 0.5 g (4.9 m/s ² 0-peak) Max. 9 - 200 Hz and 1 g (9.8 m/s ² 0-peak) Max. 2 -500 Hz and 4 g (39.2 m/s ² 0-peak) Max. 2 -500 Hz and 4 g (39.2 m/s ² 0-peak)	
Shock Operation Storage Transport	Max. 15 g (147 m/s ² 0-peak) and 11 ms length Max. 30 g (980 m/s ² 0-peak) and 11 ms length Max. 30 g (980 m/s ² 0-peak) and 11 ms length	
Height above Sea Level (operation)	2000 meters	
Drop Height	1 meter on industrial surfaces	
Flame Resistant	UL94V-0	
Protection	IP54 (with mounted handle)	

Table 11: Entire device

Technical Data • Entire Device

Electromagnetic Compatibility ²⁾	
Requirements for Emissions Network Related Emissions Electromagnetic Emissions	EN 61000-6-3, EN 55011 class A, EN 55022 class A, EN 61131-2 EN 61000-6-4, EN 55011 class A, EN 55022 class A, EN 61131-2
Requirements for Immunity to Disturbances (Immunity) Electrostatic Discharge (ESD) High-frequency Electromagnetic Fields High-speed Transient Electrical Disturbances Surge Voltages (Surge) Conducted Disturbances Magnetic Fields with Energy Technical Frequencies Voltage Dips, Fluctuations and Short-term Interruptions Damped Oscillations	EN 61000-6-2, EN 61131-2, EN 55024 EN 61000-6-2, EN 61131-2, EN 55024 EN 61000-6-2, EN 61131-2, EN 55024 EN 61000-6-2, EN 61131-2, EN 55024 EN 61000-6-2, EN 61131-2, EN 55024 EN 61000-6-2, EN 61131-2, EN 55024 EN 61000-6-2, EN 61131-2, EN 55024 EN 61131-2

Table 11: Entire device (cont.)

1) Test requirements and limits for mechanical and climate conditions see Chapter5 "Standards and Certifications" starting from Page 101.

2) In preparation. Test requirements and limits for electromagnetic compatibility see Chapter 5 "Standards and Certifications" starting from Page 101.

3. Individual Components

3.1 Operating Unit

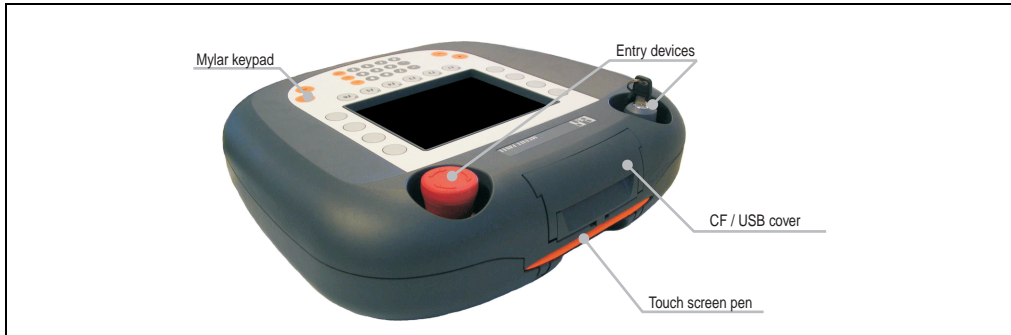

Figure 4: Mobile Panel operating unit

The operating unit contains the entire electronics such as the display, the entry devices and the Mylar keypad. For data storage and data exchange, a Compact Flash Slot (type I) and a USB 1.1 interface are available and accessible from the outside (behind the CF / USB cover). For operating touch screen devices, a touch screen pen is integrated centrally on the front.

The user interface for the operating unit is resistant to alcohol (e.g. ethanol, glycol, isopropanol, glycerine, methanol), diluted acids (e.g. vinegar-based cleaning agent), soap, cleaning agents as used in auto maintenance or industrial facilities (usually short-term exposure during the cleaning process) and normal foodstuffs (e.g. beer, wine, coffee, fruit). For instructions how to clean the device, see Chapter 6 "Accessories", section "Cleaning", on page 135.

3.1.1 Dimensions

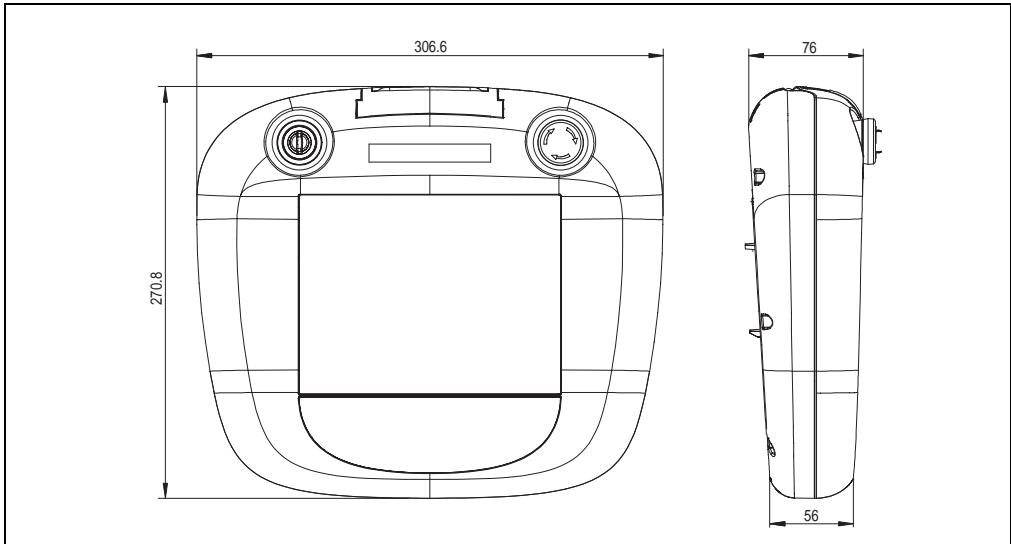

Figure 5: Operating unit dimensions

3.1.2 Mylar Keypad

Depending on the design of the Mobile Panel operating unit, it is available with softkeys or system keys, each with or without LEDs.

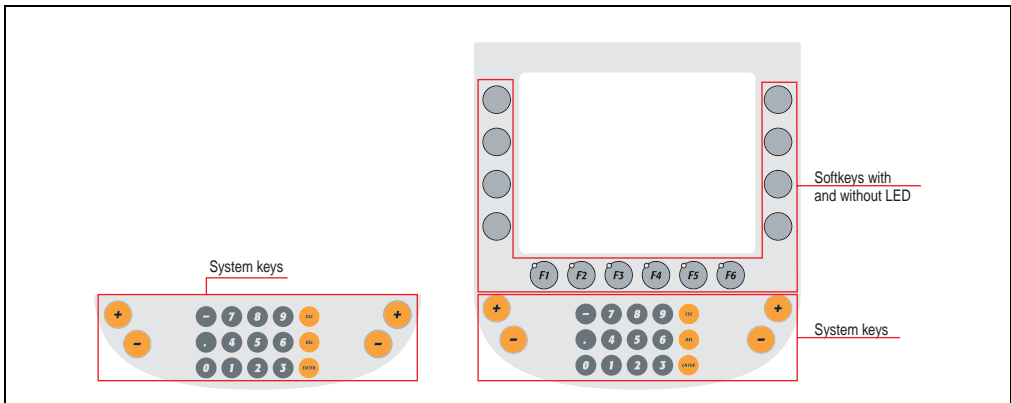

Figure 6: Example of a Mylar keypad

Softkeys

Softkeys are keys that are arranged in the immediate area of the display and refer a to function shown on the display beside the key (for example, in the form of an ICON). Additionally, softkeys have **no legend sheets**.

System Keys

Keys such as number block keys, cursor block keys, special keys for Window function or letter block keys are labeled as system keys.

3.1.3 Entry Devices

As standard, the operating unit has an E-stop button and a key switch.

E-stop Button

- 2 N.C. (2-channel)
- Pre-emptive contacts
- Protected against overload according to EN 418
- Protection against blocking
- Removal by 1/4 turning of the tappet
- Housing protection IP65 according to IEC60529

For more detailed technical data on the E-stop button and its switching element see section "E-stop button", on page 145.

Key Switch

Each restart after an emergency stop must be acknowledged by the key switch. This rules out bypassing of this acknowledgement. In addition, the key switch must be used for acknowledgement each time the Mobile Panel is started.

For example, this provides protection against unexpected restarts and protection against restarts after power fails and is restored.

- Key function, 1 N.O.
- Key can only be removed in 0 position
- IP65 housing according to IEC60529

For more detailed technical data on the key switch and its switching element see section "Key Switch", on page 146.

See section "Connection Examples for the E-stop and Key Switch", on page 86 for a connection example for the E-Stop button and the key switch using a recommended monitoring device.

3.1.4 Touch Screen Pen

The touch screen pen is attached on the front side below the CF / USB cover of a Mobile Panel device with a touch screen and is easily accessible.



Figure 7: Touch screen pen

Technical Data

Touch Screen Pen	
Material	Plastic (Cycoloy C2950), open
Color	Similar Pantone 151 CV
Dimensions	118 mm with 7 mm diameter

Table 12: Technical data for the touch screen pen

3.1.5 CF / USB Cover

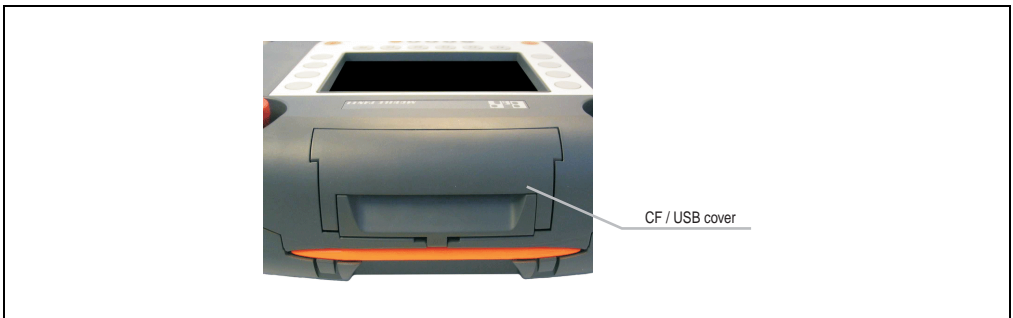

Figure 8: CF / USB cover

Behind the CF / USB cover there is a Compact Flash slot (type I) and a type A USB 1.1 port. The cover can be easily opened without tools and also with gloves.

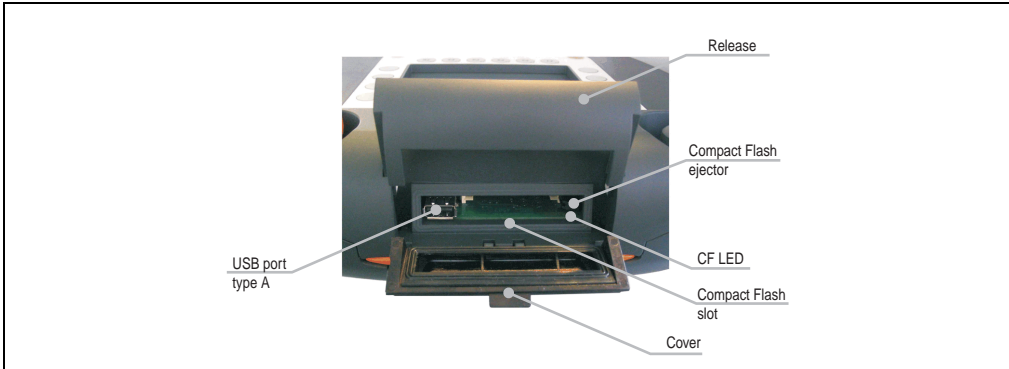

Figure 9: Compact Flash and USB slot

Compact Flash Slot

The Compact Flash slot is designed for type I Compact Flash cards and can be used as application memory and operating system memory (to open the CF/ USB cover see section "Inserting a Compact Flash Card" on Page 33).

Warning!

Inserting and removing the Compact Flash card can only take place without power applied!

Type A USB Port

For example, a USB memory stick be used for data storage, for data or recipe exchange on the type A USB port slot.

Technical Data for USB Port	
Transfer Rate	Low speed (1.5 MBit/s) to full speed (12 MBit/s)
Power Supply	500 mA
Maximum Cable Length	5 m

Table 13: Technical data for USB port connection

Warning!

Only USB devices tested and approved by B&R are allowed to be connected to the USB interface.

Warning!

Because of general PC specifications, this interface should be handled with extreme care with regard to EMC, location of cables etc.

CF LED

Information:

Mobile Panel devices offer a CF LED with revision C0 or higher.

LED	Color	Function
CF	Yellow	If the LED is lit, then this indicates the access to the Compact Flash card.

Table 14: CF LED

Inserting a Compact Flash Card

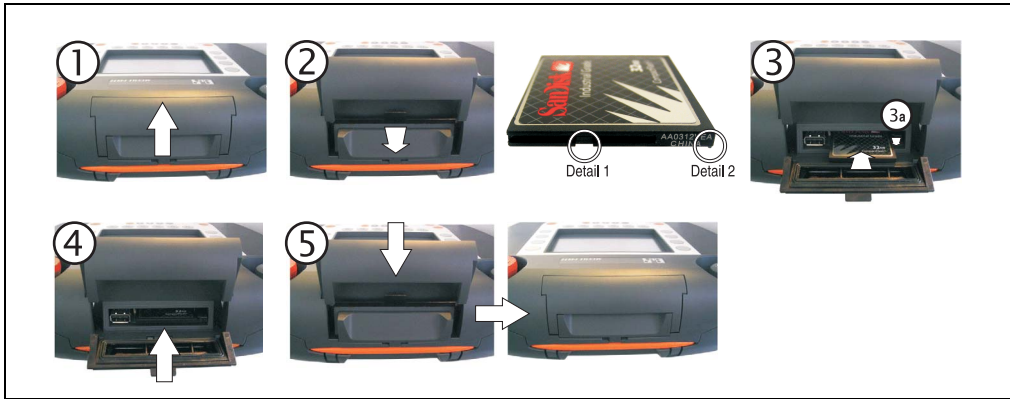

Figure 10: Inserting a Compact Flash Card

- 1) Release from above.
- 2) Open cover.
- 3) Ensure that the Compact Flash card is inserted in the correct position in the Compact Flash slot (the ridge (Detail 1) and notch (Detail 2) must be found on the underside of the Compact Flash card and in the direction of the cover). Make sure that the Compact Flash is pushed in the Compact Flash slot until this is flush with the opened Compact Flash ejection lever (see position 3a).
- 4) Fold back cover (as with position 2).

Warning!

Before closing the cover, make sure that the seal is in good condition and that it is sitting correctly!

- 5) Release as shown until the clip is pushed downwards. Only then is IP54 protection guaranteed.

Inserting a Compact Flash Card

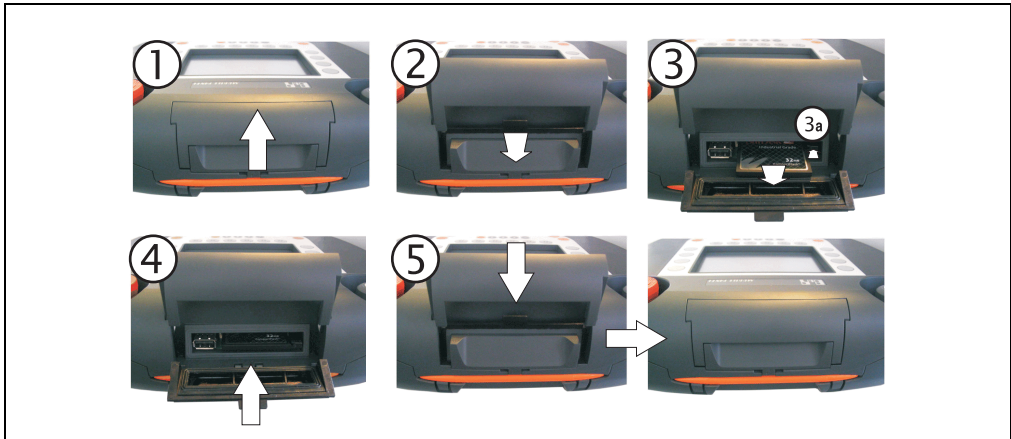

Figure 11: Removing a Compact Flash Card

- 1) Release from above.
- 2) Open cover.
- 3) Press the Compact Flash ejection lever (position 3a) and remove the Compact Flash card.
- 4) Fold back cover (as with position 2).

Warning!

Before closing the cover, make sure that the seal is in good condition and that it is sitting correctly!

- 5) Release as shown until the clip is pushed downwards. Only then is IP54 protection guaranteed.

3.1.6 Rear View of an Operating Unit

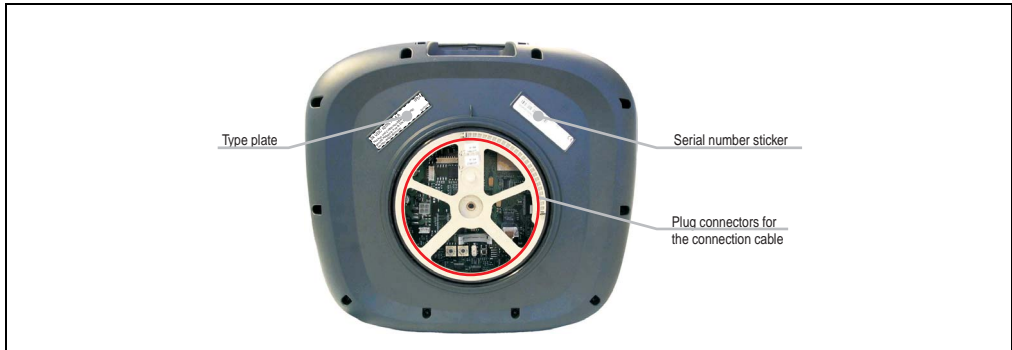

Figure 12: Operating unit - rear view

All the required insert possibilities and also software relevant switches and buttons for connecting the Mobile Panel connection cable can be found on the back (see also section "Switches, Buttons and Batteries", on page 36.

If the connection cable needs to be changed, you can find the connection plan as well as instructions for changing it in section "Exchanging the Connection Cable", on page 136.

Serial Number Label

General Information

Each B&R device is assigned a unique serial number label with bar code, which allows the device to be clearly identified.

Design/Dimensions

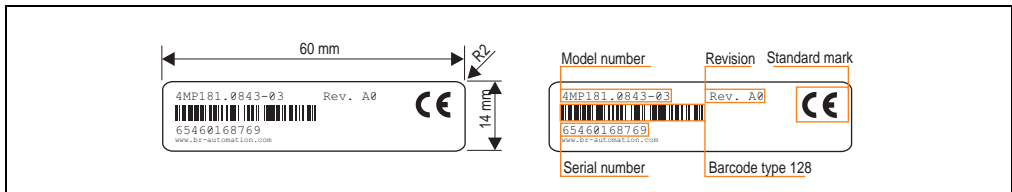

Figure 13: Design/dimensions of the serial number label

Type Plate

General Information

Regarding the enable switch, the Mobile Panel device is additionally equipped with a type plate with the following information.

Design/Dimensions

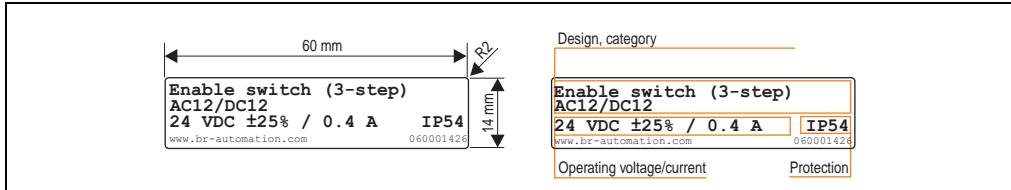

Figure 14: Design/dimensions of the type plate

The type plate is attached to the back of the Mobile Panel operating unit.

3.1.7 Switches, Buttons and Batteries

The following buttons and switches are found on the back of the operating unit for setting parameters and configuring the Mobile Panel motherboard:

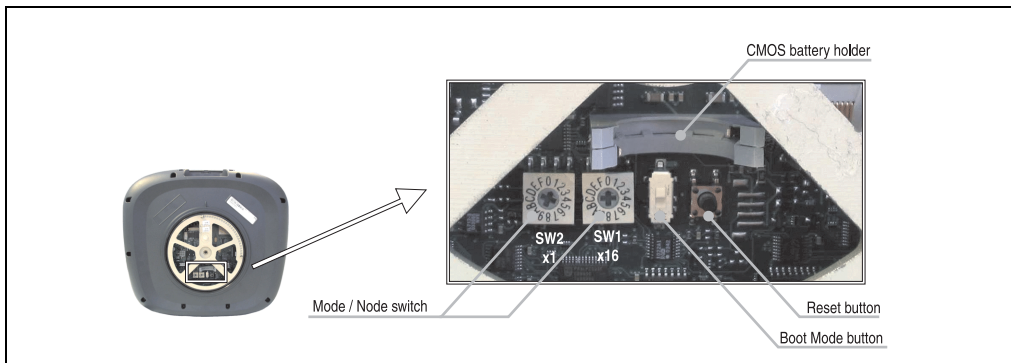

Figure 15: Back of the operating unit - switches, buttons and batteries

Mode / Node Switch

Power Panel devices are equipped with 2 hex switches, which are used as an operating mode switch for Automation Runtime devices. Switch positions 01 up to FD are available for any purpose in an application. The switch's position can be evaluated by an application program.

Switch Position		Function	Description
SW1 (x16)	SW2 (x1)	Operating Mode Switch	
0	0	Boot	Automation Runtime boot mode for operating system (firmware) upgrade (default Automation Runtime). With this mode, a new or missing operating system can be downloaded.
0 to F	0 to F	Node	Automation Runtime run mode with node 01-FD (Compact Flash Automation Runtime or terminal operation) Freely available for use in an application e.g. setting the INA2000 node number for the Ethernet interface.
F	E	Dyn. Mode	Automation Runtime run mode with node 01-FD (Compact Flash Automation Runtime or terminal operation). Device addresses can be defined by the software.
F	F	Diagnosis	Automation Runtime Diagnose Mode (Compact Flash Automation Runtime or Terminal Operation).

Table 15: Automation Runtime Switch settings for the Mode / Node switch

For Mobile Panel BIOS devices, the Mode/Node switches have the following meaning:

Switch Position		Function	Description
SW1 (x16)	SW2 (x1)	Operating Mode Switch	
0	0	Service Mode	<ul style="list-style-type: none"> When booting Windows CE, the touch screen calibration tool is started (independent of a calibrated touch screen). This function is only advantageous if the touch screen can no longer be operated (incorrect calibration, calibration data lost, etc.). The resolution for the display used is automatically configured. Contrast and brightness settings for the display are set to default values. Legacy USB support is always set to "enabled", independent of the BIOS setting.
x	x	Other switch positions have no significance	

Table 16: BIOS switch settings for the mode / node switch

CMOS Battery Holder

Used for inserting a lithium battery. The lithium battery guarantees buffering of the internal real-time clock (RTC), SRAM data, and individually saved BIOS settings.

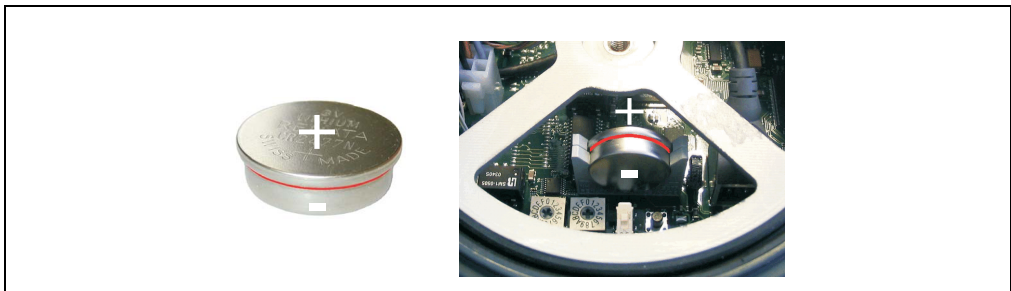

Figure 16: Inserted lithium battery

The battery status (good or bad) can be queried using software. From the point when battery capacity is recognized as insufficient, data buffering is guaranteed for approximately another 500 hours. When changing the battery, data is buffered for approximately another 10 minutes by a gold leaf capacitor. The buffer duration of the battery lasts at least two years (at 50 °C).

For more on changing the lithium battery, see Chapter 7 "Maintenance / Servicing", section "Changing the Battery", on page 141.

Boot Mode Switch

Warning!

This switch is reserved. The switch position is not allowed to be changed.

Reset Button

This button is used for resetting the Mobile Panel device.

3.1.8 Technical Data

Operating Unit 4MP181.0843-03



Figure 17: Front view 4MP181.0843-03

Information:

The following characteristics, features and limit values are only valid for these individual components and can deviate from those for the entire device. For the entire device where, for example, these individual components are used, the data given for the entire device is valid.

Features	4MP181.0843-03
Boot Loader / Operating System	Automation Runtime
Processor	Geode SC2200 266 MHz, 32-bit x86
Type	Yes
MMX Compatible	16 kByte
L1 Cache	-
L2 Cache	Yes
Floating Point Unit (FPU)	
Cooling	Passive (heat sink)
Type	
Flash	2 MB, onboard, for firmware
Memory	DRAM
Type	64 MB
Size	SO-DIMM 144-pin
Socket	
Graphics	Geode SC2200
Controller	4 MB shared memory (reserved by the main memory)
Memory	

Table 17: Technical data for 4MP181.0843-03

Technical Data • Individual Components

Features	4MP181.0843-03
SRAM Size Battery buffered	-
Watch Dog Controller	-
Power Fail Logic Controller Hold-up Time	-
Real-time Clock ¹⁾ Battery Buffered Precision	Not battery buffered ±20 ppm
Battery Type Can be Exchanged Lifespan Backup Capacitor Hold-up Time	-
Ethernet Controller Transfer Rate Connection Cables	MacPhyter DP83816 10/100 Mbit/s RJ45 Twisted Pair (10 BaseT / 100 BaseT) S/STP (Category 5, using Mobile Panel cable)
CAN bus Controller Transfer Rate Connection	-
Compact Flash Type Amount Connection	Accessible behind the CF / USB cover Type I 1 Primary IDE
Serial Interface Type UART Transfer Rate Connection	RS232 (RxD and TxD), not modem-capable 16550 compatible, 16 byte FIFO Max. 115 kBaud Connection using the Mobile Panel cable
USB Interface Type Amount Transfer Rate Connection	Accessible behind the CF / USB cover USB 1.1 2 1.5 Mbit/s (Low Speed), 12 Mbit/s (Full Speed) Type A
Reset Button	Yes (accessible using the handle)
Mode / Node Switch	2 pcs. each 16 digits (back side accessible using the handle)
LED ²⁾	1 LED CF (yellow) - can be accessed behind the CF / USB cover
Display Type Diagonal Colors Resolution Background Lighting Brightness Half-Brightness Time	TFT 8.4 in 256 Colors VGA, 640 x 480 pixels 120 cd/m ² 50000 hours

Table 17: Technical data for 4MP181.0843-03 (cont.)

Features	4MP181.0843-03
Touch Screen Technology Controller Transmission Degree	Analog, resistive Hampshire, serial, 12-bit 78 %
Filter glass Transmission Degree Coating	-
Keys Function Keys Softkeys Cursor Pad Number Block Other Keys	- - - 15 without LED 4 without LED
Power Supply Rated Voltage Starting Current Power Input Electrical Isolation	24 VDC \pm 25% For short time (approx. 1 ms) 20 A Approx. 8 Watt typically, max. 10 Watt -
Mechanics	4MP181.0843-03
Operating Unit Paint, Color	Double-walled housing from plastic (Cycoloy C2950) Soft-touch coating, similar RAL7016
E-stop	Yes (2 N.C.), right position
Key Switch	Yes (1 normally open, momentary), left position
Touch Screen Pen Color	Yes Similar Pantone 151 CV
Outer Dimensions in mm (WxHxD) Without Handle	306.6 x 76 x 270.6
Weight (without handle, Compact Flash card and connection cable)	1900 grams
Environment	4MP181.0843-03
Environmental Temperature Operation Storage Transport	0 °C to 45 °C -20 °C to +70 °C -20 °C to +70 °C
Humidity Operation Storage Transport	Max. 95 % at T \leq 40°C (non-condensing) Max. 95 % at T \leq 40°C (non-condensing) Max. 95 % at T \leq 40°C (non-condensing)
Vibration Operation (continuous) Operation (occasional) Storage Transport	Max. 9 - 200 Hz and 0.5 g (4.9 m/s ² 0-peak) Max. 9 - 200 Hz and 1 g (9.8 m/s ² 0-peak) Max. 2 - 500 Hz and 4 g (39.2 m/s ² 0-peak) Max. 2 - 500 Hz and 4 g (39.2 m/s ² 0-peak)
Shock Operation Storage Transport	Max. 15 g (147 m/s ² 0-peak) and 11 ms length Max. 30 g (980 m/s ² 0-peak) and 11 ms length Max. 30 g (980 m/s ² 0-peak) and 11 ms length

Table 17: Technical data for 4MP181.0843-03 (cont.)

Technical Data • Individual Components

Environment	4MP181.0843-03
Protection	IP54 (with mounted handle)
Altitude	2000 meters
Drop Height	1 meter on industrial surfaces
Flame Resistant	UL94V-0

Table 17: Technical data for 4MP181.0843-03 (cont.)

- 1) The quartz used with the Mobile Panel has an accuracy of ± 20 ppm. That means the deviation is typically 5 seconds per day under consideration of influences such as temperature and wiring of the quartz.ay.
- 2) Mobile Panel devices with revision C0 or higher offer a Compact Flash write/read access LED.

Operating Unit 4MP251.0571-12



Figure 18: Front View 4MP251.0571-12

Information:

The following characteristics, features and limit values are only valid for these individual components and can deviate from those for the entire device. For the entire device where, for example, these individual components are used, the data given for the entire device is valid.

Features	4MP251.0571-12
Boot Loader / Operating System	Automation Runtime
Processor	Geode SC2200 266 MHz, 32-bit x86
Type	Yes
MMX Compatible	Yes
L1 Cache	16 kByte
L2 Cache	-
Floating Point Unit (FPU)	Yes
Cooling	
Type	Passive (heat sink)
Flash	2 MB, onboard, for firmware
Memory	
Type	DRAM
Size	64 MB
Socket	SO-DIMM 144-pin
Graphics	
Controller	Geode SC2200
Memory	4 MB shared memory (reserved by the main memory)

Table 18: Technical data for 4MP251.0571-12

Technical Data • Individual Components

Features	4MP251.0571-12
SRAM Size Battery Buffered	256 kByte Yes
Watch Dog Controller	SMC ¹⁾
Power Fail Logic Controller Hold-up Time	-
Real-time Clock ²⁾ Battery Buffered Precision	Yes ±20 ppm
Battery Type Can be Exchanged Lifespan Backup Capacitor Hold-up Time	Lithium Renata 950 mAh Yes, rear-side accessible using the handle At least 2 years at 50° C Yes 10 Minutes
Ethernet Controller Transfer Rate Connection Cables	MacPhyter DP83816 10/100 Mbit/s RJ45 Twisted Pair (10 BaseT / 100 BaseT) S/STP (Category 5, using Mobile Panel cable)
CAN bus Controller Transfer Rate Connection	Electrically isolated SJA1000 Max. 1 Mbits/s Connection via Mobile Panel cable
Compact Flash Type Amount Connection	Accessible behind the CF / USB cover Type I 1 Primary IDE
Serial Interface Type UART Transfer Rate Connection	RS232 (Rx and Tx), not modem-capable 16550 compatible, 16 byte FIFO Max. 115 kBaud Connection using the Mobile Panel cable
USB interface Type Amount Transfer Rate Connection	Accessible behind the CF / USB cover USB 1.1 2 1.5 Mbit/s (Low Speed), 12 Mbit/s (Full Speed) Type A
Reset Button	Yes (accessible using the handle)
Mode / Node Switch	2 pcs. each 16 digits (back side accessible using the handle)
LED ³⁾	1 LED CF (yellow) - can be accessed behind the CF / USB cover
Display Type Diagonal Colors Resolution Background Lighting Brightness Half-Brightness Time	LCD 5.7 in 256 Colors QVGA, 320 x 240 pixels 150 cd/m ² 50000 hours

Table 18: Technical data for 4MP251.0571-12 (cont.)

Features	4MP251.0571-12
Touch Screen Technology Controller Transmission Degree	-
Filter Glass Transmission Degree Coating	> 98 % Multiple double-sided
Keys Function Keys Softkeys Cursor Pad Number Block Other Keys	- 14 - 15 without LED 4 without LED
Power Supply Rated Voltage Starting Current Power Input Electrical Isolation	24 VDC ± 25% For short time (approx. 1 ms) 20 A Approx. 8 Watt typically, max. 10 Watt -
Mechanics	4MP251.0571-12
Operating Unit Paint, Color	Double-walled housing from plastic (Cycoloy C2950) Soft-touch coating, similar RAL7016
E-stop	Yes (2 N.C.), right position
Key Switch	Yes (1 normally open, momentary), left position
Touch Screen Pen Color	-
Outer Dimensions in mm (WxHxD) Without Handle	306.6 x 76 x 270.6
Weight (without handle, Compact Flash card and connection cable)	1650 grams
Environment	4MP251.0571-12
Environmental Temperature Operation Storage Transport	0 °C to 45 °C -20 °C to +60° C -20 °C to +60° C
Humidity Operation Storage Transport	Max. 95 % at T ≤ 40°C (non-condensing) Max. 95 % at T ≤ 40°C (non-condensing) Max. 95 % at T ≤ 40°C (non-condensing)
Vibration Operation (continuous) Operation (occasional) Storage Transport	Max. 9 - 200 Hz and 0.5 g (4.9 m/s ² 0-peak) Max. 9 - 200 Hz and 1 g (9.8 m/s ² 0-peak) Max. 2 - 500 Hz and 4 g (39.2 m/s ² 0-peak) Max. 2 - 500 Hz and 4 g (39.2 m/s ² 0-peak)
Shock Operation Storage Transport	Max. 15 g (147 m/s ² 0-peak) and 11 ms length Max. 30 g (980 m/s ² 0-peak) and 11 ms length Max. 30 g (980 m/s ² 0-peak) and 11 ms length

Table 18: Technical data for 4MP251.0571-12 (cont.)

Technical Data • Individual Components

Environment	4MP251.0571-12
Protection	IP54 (with mounted handle)
Altitude	2000 meters
Drop Height	1 meter on industrial surfaces
Flame Resistant	UL94V-0

Table 18: Technical data for 4MP251.0571-12 (cont.)

- 1) **System Management Controller.**
- 2) The quartz used with the Mobile Panel has an accuracy of ± 20 ppm. That means the deviation is typically 5 seconds per day under consideration of influences such as temperature and wiring of the quartz.ay.
- 3) Mobile Panel devices with revision C0 or higher offer a Compact Flash write/read access LED.

Operating Unit 4MP281.0571-12



Figure 19: Front view 4MP281.0571-12

Information:

The following characteristics, features and limit values are only valid for these individual components and can deviate from those for the entire device. For the entire device where, for example, these individual components are used, the data given for the entire device is valid.

Features	4MP281.0571-12
Boot Loader / Operating System	Automation Runtime
Processor	
Type	Geode SC2200 266 MHz, 32-bit x86
MMX Compatible	Yes
L1 Cache	16 kByte
L2 Cache	-
Floating Point Unit (FPU)	Yes
Cooling	
Type	Passive (heat sink)
Flash	2 MB, onboard, for firmware
Memory	
Type	DRAM
Size	64 MB
Socket	SO-DIMM 144-pin
Graphics	
Controller	Geode SC2200
Memory	4 MB shared memory (reserved by the main memory)

Table 19: Technical data 4MP281.0571-12

Technical Data • Individual Components

Features	4MP281.0571-12
SRAM Size Battery Buffered	256 kByte Yes
Watch Dog Controller	SMC ¹⁾
Power Fail Logic Controller Hold-up Time	-
Real-time Clock ²⁾ Battery Buffered Precision	Yes ±20 ppm
Battery Type Can be Exchanged Lifespan Backup Capacitor Hold-up Time	Lithium Renata 950 mAh Yes, rear-side accessible using the handle At least 2 years at 50° C Yes 10 Minutes
Ethernet Controller Transfer Rate Connection Cables	MacPhyter DP83816 10/100 Mbit/s RJ45 Twisted Pair (10 BaseT / 100 BaseT) S/STP (Category 5, using Mobile Panel cable)
CAN bus Controller Transfer Rate Connection	Electrically isolated SJA1000 Max. 1 Mbits/s Connection via Mobile Panel cable
Compact Flash Type Amount Connection	Accessible behind the CF / USB cover Type I 1 Primary IDE
Serial Interface Type UART Transfer Rate Connection	RS232 (RxD and TxD), not modem-capable 16550 compatible, 16 byte FIFO Max. 115 kBaud Connection using the Mobile Panel cable
USB Interface Type Amount Transfer Rate Connection	Accessible behind the CF / USB cover USB 1.1 2 1.5 Mbit/s (Low Speed), 12 Mbit/s (Full Speed) Type A
Reset Button	Yes (accessible using the handle)
Mode / Node Switch	2 pcs. each 16 digits (back side accessible using the handle)
LED ³⁾	1 LED CF (yellow) - can be accessed behind the CF / USB cover
Display Type Diagonal Colors Resolution Background Lighting Brightness Half-Brightness Time	LCD 5.7 in 256 Colors QVGA, 320 x 240 pixels 150 cd/m ² 50000 hours

Table 19: Technical data 4MP281.0571-12 (cont.)

Features	4MP281.0571-12
Touch Screen Technology Controller Transmission Degree	Analog, resistive Hampshire, serial, 12-bit 78 %
Filter glass Transmission Degree Coating	-
Keys Function Keys Softkeys Cursor Pad Number Block Other Keys	- 14 - 15 without LED 4 without LED
Power Supply Rated Voltage Starting Current Power Input Electrical Isolation	24 VDC ± 25% For short time (approx. 1 ms) 20 A Approx. 8 Watt typically, max. 10 Watt -
Mechanics	4MP281.0571-12
Operating Unit Paint, Color	Double-walled housing from plastic (Cycoloy C2950) Soft-touch coating, similar RAL7016
E-stop	Yes (2 N.C.), right position
Key Switch	Yes (1 normally open, momentary), left position
Touch Screen Pen Color	Yes Similar Pantone 151 CV
Outer Dimensions in mm (WxHxD) Without Handle	306.6 x 76 x 270.6
Weight (without handle, Compact Flash card and connection cable)	1650 grams
Environment	4MP281.0571-12
Environmental Temperature Operation Storage Transport	0 °C to 45 °C -20 °C to +60° C -20 °C to +60° C
Humidity Operation Storage Transport	Max. 85% at T ≤ 40 °C (non-condensing) Max. 85% at T ≤ 40 °C (non-condensing) Max. 85% at T ≤ 40 °C (non-condensing)
Vibration Operation (continuous) Operation (occasional) Storage Transport	Max. 9 - 200 Hz and 0.5 g (4.9 m/s ² 0-peak) Max. 9 - 200 Hz and 1 g (9.8 m/s ² 0-peak) Max. 2 - 500 Hz and 4 g (39.2 m/s ² 0-peak) Max. 2 - 500 Hz and 4 g (39.2 m/s ² 0-peak)
Shock Operation Storage Transport	Max. 15 g (147 m/s ² 0-peak) and 11 ms length Max. 30 g (980 m/s ² 0-peak) and 11 ms length Max. 30 g (980 m/s ² 0-peak) and 11 ms length

Table 19: Technical data 4MP281.0571-12 (cont.)

Technical Data • Individual Components

Environment	4MP281.0571-12
Protection	IP54 (with mounted handle)
Altitude	2000 meters
Drop Height	1 meter on industrial surfaces
Flame Resistant	UL94V-0

Table 19: Technical data 4MP281.0571-12 (cont.)

- 1) **System Management Controller.**
- 2) The quartz used with the Mobile Panel has an accuracy of ± 20 ppm. That means the deviation is typically 5 seconds per day under consideration of influences such as temperature and wiring of the quartz.ay.
- 3) Mobile Panel devices with revision C0 or higher offer a Compact Flash write/read access LED.

Operating Unit 4MP281.0843-13



Figure 20: Front view for 4MP281.0843-13

Information:

The following characteristics, features and limit values are only valid for these individual components and can deviate from those for the entire device. For the entire device where, for example, these individual components are used, the data given for the entire device is valid.

Features	4MP281.0843-13
Boot Loader / Operating System	Automation Runtime
Processor	Geode SC2200 266 MHz, 32-bit x86
Type	Yes
MMX Compatible	Yes
L1 Cache	16 kByte
L2 Cache	-
Floating Point Unit (FPU)	Yes
Cooling	
Type	Passive (heat sink)
Flash	2 MB, onboard, for firmware
Memory	
Type	DRAM
Size	64 MB
Socket	SO-DIMM 144-pin
Graphics	
Controller	Geode SC2200
Memory	4 MB shared memory (reserved by the main memory)

Table 20: Technical data 4MP281.0843-13

Technical Data • Individual Components

Features	4MP281.0843-13
SRAM Size Battery Buffered	256 kByte Yes
Watch Dog Controller	SMC ¹⁾
Power Fail Logic Controller Hold-up Time	-
Real-time Clock ²⁾ Battery Buffered Precision	Yes ±20 ppm
Battery Type Can be Exchanged Lifespan Backup Capacitor Hold-up Time	Lithium Renata 950 mAh Yes, rear-side accessible using the handle At least 2 years at 50° C Yes 10 Minutes
Ethernet Controller Transfer Rate Connection Cables	MacPhyter DP83816 10/100 Mbit/s RJ45 Twisted Pair (10 BaseT / 100 BaseT) S/STP (Category 5, using Mobile Panel cable)
CAN Bus Controller Transfer Rate Connection	-
Compact Flash Type Amount Connection	Accessible behind the CF / USB cover Type I 1 Primary IDE
Serial Interface Type UART Transfer Rate Connection	RS232 (RxD and TxD), not modem-capable 16550 compatible, 16 byte FIFO Max. 115 kBaud Connection using the Mobile Panel cable
USB Interface Type Amount Transfer Rate Connection	Accessible behind the CF / USB cover USB 1.1 2 1.5 Mbit/s (Low Speed), 12 Mbit/s (Full Speed) Type A
Reset Button	Yes (accessible using the handle)
Mode / Node Switch	2 pcs. each 16 digits (back side accessible using the handle)
LED ³⁾	1 LED CF (yellow) - can be accessed behind the CF / USB cover
Display Type Diagonal Colors Resolution Background Lighting Brightness Half-Brightness Time	TFT 8.4 in 256 Colors VGA, 640 x 480 pixels 120 cd/m ² 50000 hours

Table 20: Technical data 4MP281.0843-13 (cont.)

Features	4MP281.0843-13
Touch Screen Technology Controller Transmission Degree	Analog, resistive Hampshire, serial, 12-bit 78 %
Filter Glass Transmission Degree Coating	-
Keys Function Keys Softkeys Cursor Pad Number Block Other Keys	- - - 15 without LED 4 without LED
Power Supply Rated Voltage Starting Current Power Input Electrical Isolation	24 VDC ± 25% For short time (approx. 1 ms) 20 A Approx. 8 Watt typically, max. 10 Watt -
Mechanics	4MP281.0843-13
Operating Unit Paint, Color	Double-walled housing from plastic (Cycoloy C2950) Soft-touch coating, similar RAL7016
E-stop	Yes (2 N.C.), right position
Key Switch	Yes (1 normally open, momentary), left position
Touch Screen Pen Color	Yes Similar Pantone 151 CV
Outer Dimensions in mm (WxHxD) Without Handle	306.6 x 76 x 270.6
Weight (without handle, Compact Flash card and connection cable)	1900 grams
Environment	4MP281.0843-13
Environmental Temperature Operation Storage Transport	0 °C to 45 °C -20 °C to +70 °C -20 °C to +70 °C
Humidity Operation Storage Transport	Max. 95 % at T ≤ 40°C (non-condensing) Max. 95 % at T ≤ 40°C (non-condensing) Max. 95 % at T ≤ 40°C (non-condensing)
Vibration Operation (continuous) Operation (occasional) Storage Transport	Max. 9 - 200 Hz and 0.5 g (4.9 m/s ² 0-peak) Max. 9 - 200 Hz and 1 g (9.8 m/s ² 0-peak) Max. 2 - 500 Hz and 4 g (39.2 m/s ² 0-peak) Max. 2 - 500 Hz and 4 g (39.2 m/s ² 0-peak)
Shock Operation Storage Transport	Max. 15 g (147 m/s ² 0-peak) and 11 ms length Max. 30 g (980 m/s ² 0-peak) and 11 ms length Max. 30 g (980 m/s ² 0-peak) and 11 ms length

Table 20: Technical data 4MP281.0843-13 (cont.)

Technical Data • Individual Components

Environment	4MP281.0843-13
Protection	IP54 (with mounted handle)
Altitude	2000 meters
Drop Height	1 meter on industrial surfaces
Flame Resistant	UL94V-0

Table 20: Technical data 4MP281.0843-13 (cont.)

- 1) **System Management Controller.**
- 2) The quartz used with the Mobile Panel has an accuracy of ± 20 ppm. That means the deviation is typically 5 seconds per day under consideration of influences such as temperature and wiring of the quartz.ay.
- 3) Mobile Panel devices with revision C0 or higher offer a Compact Flash write/read access LED.

Operating Unit for 5MP181.0843-07



Figure 21: Front View 5MP181.0843-07

Information:

The following characteristics, features and limit values are only valid for these individual components and can deviate from those for the entire device. For the entire device where, for example, these individual components are used, the data given for the entire device is valid.

Features	5MP181.0843-07
Boot Loader / Operating System	BIOS
Processor	Geode SC2200 266 MHz, 32-bit x86
Type	Geode SC2200 266 MHz, 32-bit x86
MMX Compatible	Yes
L1 Cache	16 kByte
L2 Cache	-
Floating Point Unit (FPU)	Yes
Cooling	
Type	Passive (heat sink)
Flash	2 MB, onboard, for firmware
Memory	
Type	DRAM
Size	128 MB
Socket	SO-DIMM 144-pin
Graphics	
Controller	Geode SC2200
Memory	4 MB shared memory (reserved by the main memory)

Table 21: Technical data for 5MP181.0843-07

Technical Data • Individual Components

Features	5MP181.0843-07
SRAM Size Battery Buffered	-
Watch Dog Controller	-
Power Fail Logic Controller Hold-up Time	-
Real-time Clock ¹⁾ Battery Buffered Precision	Yes ±20 ppm
Battery Type Can be Exchanged Lifespan Backup Capacitor Hold-up Time	Lithium Renata 950 mAh Yes, rear-side accessible using the handle At least 2 years at 50° C Yes 10 Minutes
Ethernet Controller Transfer Rate Connection Cables	MacPhyter DP83816 10/100 Mbit/s RJ45 Twisted Pair (10 BaseT / 100 BaseT) S/STP (Category 5, using Mobile Panel cable)
CAN Bus Controller Transfer Rate Connection	-
Compact Flash Type Amount Connection	Accessible behind the CF / USB cover Type I 1 Primary IDE
Serial Interface Type UART Transfer Rate Connection	RS232 (RxD and TxD), not modem-capable 16550 compatible, 16 byte FIFO Max. 115 kBaud Connection using the Mobile Panel cable
USB Interface Type Amount Transfer Rate Connection	Accessible behind the CF / USB cover USB 1.1 2 1.5 Mbit/s (Low Speed), 12 Mbit/s (Full Speed) Type A
Reset Button	Yes (accessible using the handle)
Mode / Node Switch	2 pcs. each 16 digits (back side accessible using the handle)
LED ²⁾	1 LED CF (yellow) - can be accessed behind the CF / USB cover
Display Type Diagonal Colors Resolution Background Lighting Brightness Half-Brightness Time	TFT 8.4 in 262144 Colors VGA, 640 x 480 pixels 120 cd/m ² 50000 hours

Table 21: Technical data for 5MP181.0843-07 (cont.)

Features	5MP181.0843-07
Touch Screen Technology Controller Transmission Degree	Analog, resistive Hampshire, serial, 12-bit 78 %
Filter Glass Transmission Degree Coating	-
Keys Function Keys Softkeys Cursor Pad Number Block Other Keys	- - - 15 without LED 4 without LED
Power Supply Rated Voltage Starting Current Power Input Electrical Isolation	24 VDC ± 25% For short time (approx. 1 ms) 20 A Approx. 8 Watt typically, max. 10 Watt -
Mechanics	5MP181.0843-07
Operating Unit Paint, Color	Double-walled housing from plastic (Cycoloy C2950) Soft-touch coating, similar RAL7016
E-stop	Yes (2 N.C.), right position
Key Switch	Yes (1 normally open, momentary), left position
Touch Screen Pen Color	Yes Similar Pantone 151 CV
Outer Dimensions in mm (WxHxD) Without Handle	306.6 x 76 x 270.6
Weight (without handle, Compact Flash card and connection cable)	1900 grams
Environment	5MP181.0843-07
Environmental Temperature Operation Storage Transport	0 °C to 45 °C -20 °C to +70 °C -20 °C to +70 °C
Humidity Operation Storage Transport	Max. 95 % at T ≤ 40°C (non-condensing) Max. 95 % at T ≤ 40°C (non-condensing) Max. 95 % at T ≤ 40°C (non-condensing)
Vibration Operation (continuous) Operation (occasional) Storage Transport	Max. 9 - 200 Hz and 0.5 g (4.9 m/s ² 0-peak) Max. 9 - 200 Hz and 1 g (9.8 m/s ² 0-peak) Max. 2 - 500 Hz and 4 g (39.2 m/s ² 0-peak) Max. 2 - 500 Hz and 4 g (39.2 m/s ² 0-peak)
Shock Operation Storage Transport	Max. 15 g (147 m/s ² 0-peak) and 11 ms length Max. 30 g (980 m/s ² 0-peak) and 11 ms length Max. 30 g (980 m/s ² 0-peak) and 11 ms length

Table 21: Technical data for 5MP181.0843-07 (cont.)

Technical Data • Individual Components

Environment	5MP181.0843-07
Protection	IP54 (with mounted handle)
Altitude	2000 meters
Drop Height	1 meters on industrial surfaces
Flame Resistant	UL94V-0

Table 21: Technical data for 5MP181.0843-07 (cont.)

- 1) The quartz used with the Mobile Panel has an accuracy of ± 20 ppm. That means the deviation is typically 5 seconds per day under consideration of influences such as temperature and wiring of the quartz.ay.
- 2) Mobile Panel devices with revision C0 or higher offer a Compact Flash write/read access LED.

3.2 Handle



Figure 22: Operating unit, handle and connection cable

The handle is designed ergonomically for both right-handers and left-handers. The connection to the operating unit takes is made using threaded screws. The threaded screws can be loosened with a hex screw (size 4 mm) and removed (for more on this, see section "Operating Unit Fastener", on page 62).

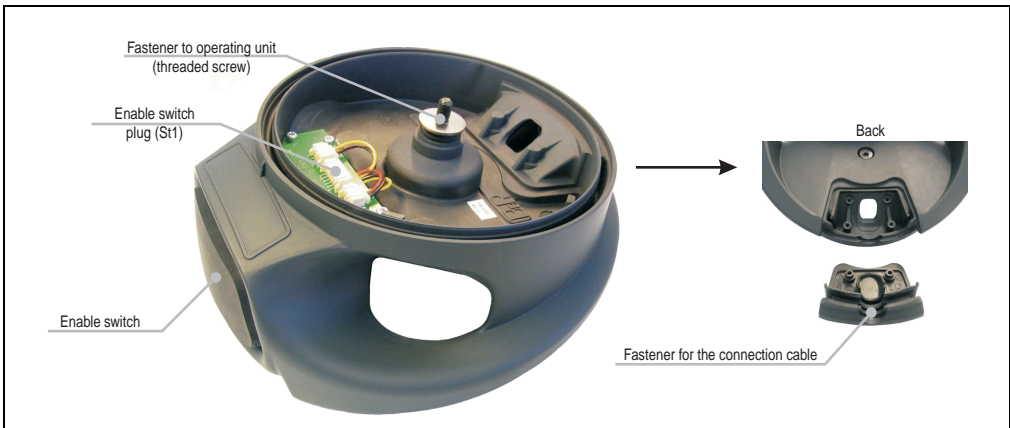

Figure 23: Handle 4MPHDL.0000-00

3.2.1 Dimensions

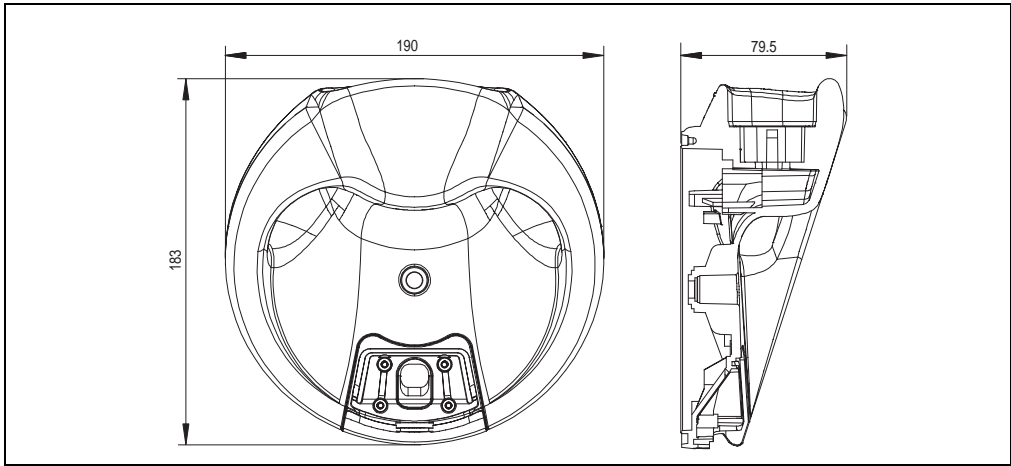

Figure 24: Dimensions for the handle

3.2.2 Technical Data

Mechanics	4MPHDL.0000-00
Material Paint, Color	Plastic (pure compact foam) Soft-touch coating, similar RAL7016
Dimensions (WxHxD)	190 x 79.5 x 183
Weight	540 grams
Enable Switch	3-step (null, enable, panic position)

Table 22: Technical data 4MPHDL.0000-00

3.2.3 Enable Switch

The handle has a 3-step, 2-channel enable switch, which is attached centrally on the front side of the handle.

The enable switch is used to implement enabling equipment as a protective function for machines or systems in special operating modes. The enable switch is only part of this setup.

- 3-step: null, enable and panic position

For more detailed technical data on the enable switch see section "Enable Switch", on page 147.

Functionality

The enable button switch is 2-channel, each having 3 switch positions.

Position	Enable Switch/Activation
Null	Not pressed
Enable	Pressed
Panic	Pushed through

Table 23: Switch positions for the enable switch

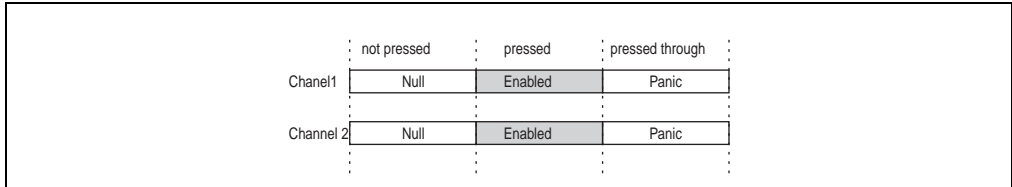

Figure 25: Possible enable switch positions

Both enable switches must always have the same position so that the switch position is easily found by the monitoring device.

The positions "null" and "panic" must trigger a stop command for category 0 or 1.

Null Position

The enable switch remains deactivated in the null position (not enabled).

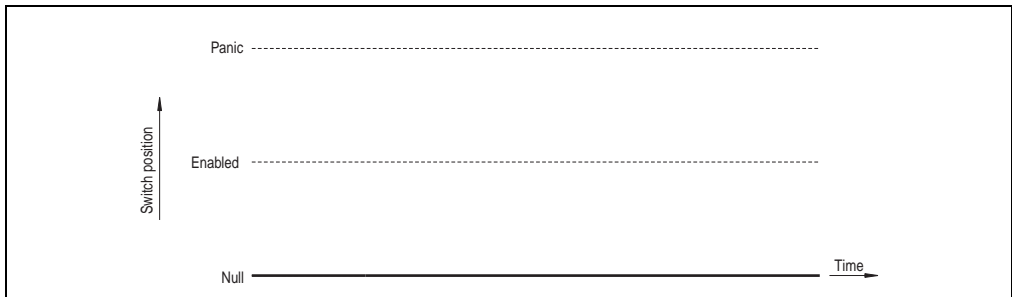

Figure 26: Enable switch - position null

Enable Position

The enable position is the operating mode for the enable switch. In this position, it is possible to initiate a movement for an axis by subsequently pressing a direction button.

The enable switch is pressed from the null position to the enable position. After being released, it goes back to the null position again.

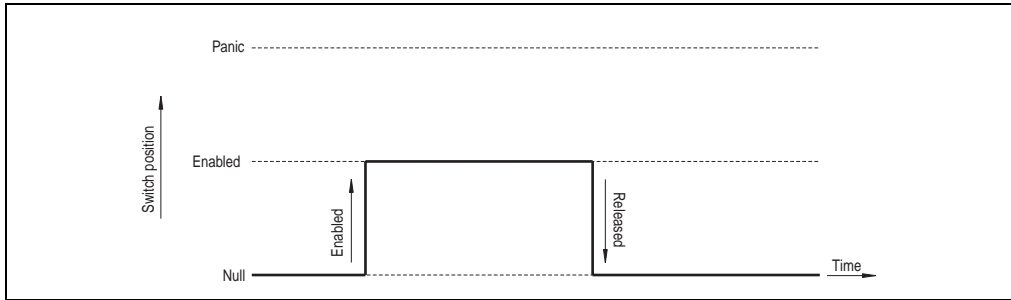

Figure 27: Enable switch - position enable

Panic Position

If the enable switch is pushed through (enable position to panic position), the enable position is skipped and it goes to the null position after being released.

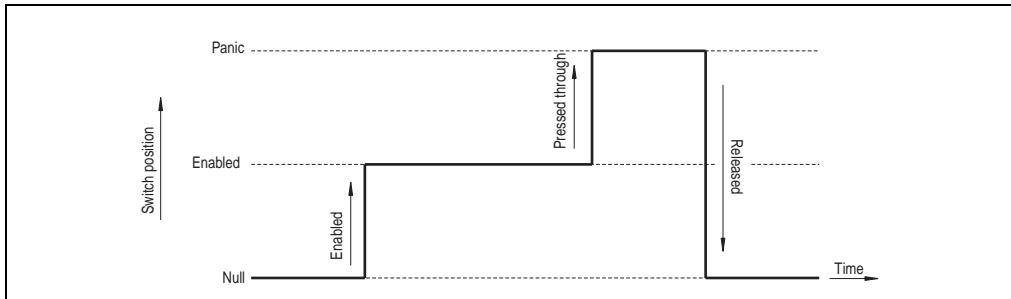

Figure 28: Enable switch - position panic

See section "Connection Example for the Enable Switch", on page 90 for a connection example for the enable button with a recommended monitoring device.

3.2.4 Operating Unit Fastener

The threaded screws can be loosened with a hex key (4 mm). The handle and the operating unit are fastened together using the threaded screw.

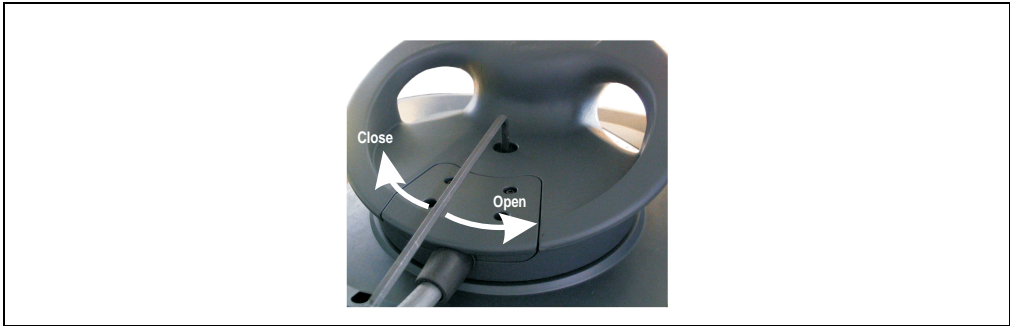

Figure 29: Fastening/removing the handle to/from the operating unit

The handle can also be turned without unfastening it.

3.2.5 Fastening the Connection Cable

The cable is connected using a stress relief and fastened tightly. A size 10 torx screwdriver is needed for this.

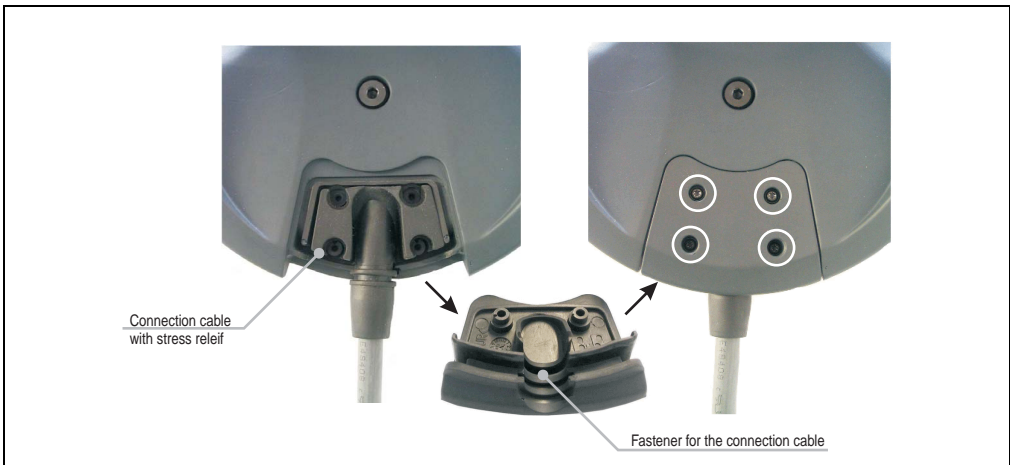

Figure 30: Fastening the connection cable

3.3 Connection Cable

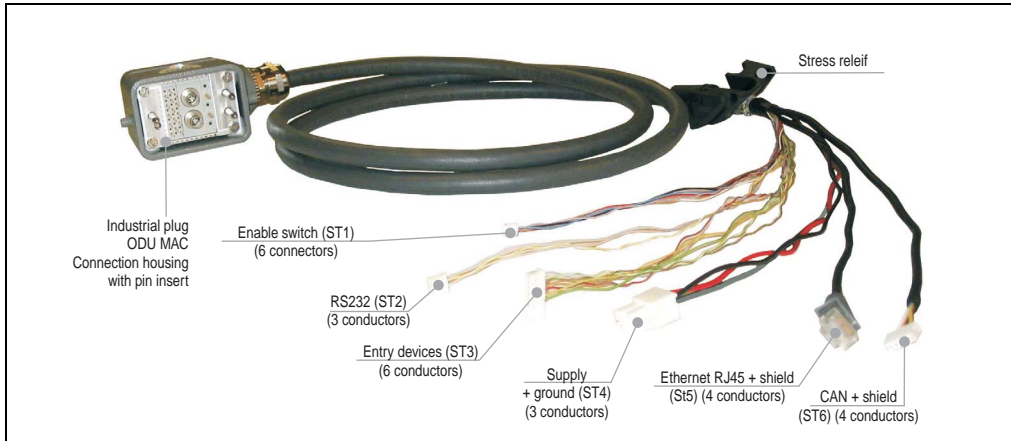

Figure 31: Connection cable 5CAMPH.0xxx-00

The connection cable establishes the electrical and mechanical connection between the switching cabinet and Mobile Panel. It includes lines for the network (Ethernet 10/100 MBit/s), supply 24 VDC, entry devices, enable switch, serial data transfer and CAN.

The surface is protected against water, oil (protected against lubricating and hydraulic oils according to EN 60811 section 2-1) and cooling lubricant.

The connection cable is mounted on the side of the Mobile Panel in the handle. The switching cabinet end of the connection cable is an industrial connector. The connection cable is available in different lengths (see table 5 "Model numbers for Mobile Panel connection cables" on Page 18). Information regarding the procedure for exchanging the connection cable can be found in the section "Exchanging the Connection Cable", on page 136.



Figure 32: Connection cable and handle

3.3.1 Technical Data

Information:

The following characteristics, features and limit values are only valid for these individual components and can deviate from those for the entire device. For the entire device where, for example, these individual components are used, the data given for the entire device is valid.

Features	5CAMPH.0050-00	5CAMPH.0070-00	5CAMPH.0100-00	5CAMPH.0150-00	5CAMPH.0200-00
Length and Tolerance	5 meters ± 10 cm	7 meters ± 10 cm	10 meters ± 10 cm	15 meters ± 15 cm	15 meter s ± 15 cm
Connector Industrial Connector	Connection housing with pin insert				
Cables Total Diameter Weight per Meter Shielding Material Available Lengths Minimum Flex Radius Supply Lines Permissible Operating Voltage Material Conductor Resistance Maximum Tension Stress Color	Hybrid cable, 25 conductor 10 mm 153 grams Silicon and halogen free, flame retardant PUR outer sheathing See table 5 "Model numbers for Mobile Panel connection cables" on Page 18 60 mm 30 VDC Tinned copper wires ≤ 30 Ohm/km 140 N Similar to RAL 7012				
Cable Elements Network Enable Switch 2 x CAN Bus Entry Devices Power Supply Serial Connection (RxD, TxD)	Twisted pair cable for Ethernet (10/100 MBit/s) (4-wire RJ45 plug) Direct connection between the enable switch and the monitoring device (6-wire) 2 pairs with shielding (4-wire) Direct connection between the entry device and the monitoring device (6-wire) Supply voltage + 24 VDC (2-wire) 3 Wires				
Environment					
Operating Temperature Non-moving State Moving State	-20 °C to +80 °C -5 °C to +60° C				
Standards	Flame retardant in accordance with IEC 60332-1 and VW1 / FT1 in accordance with C-UL Shield damping in accordance with IEC 60096-1, amendment 2 Mechanical characteristics according to DIN VDE 0472 section 603 test type H (100000 cycles) Oil resistant, hydrolysis resistant according to DIN VDE 0282 section 10				

Table 24: Technical data for the Mobile Panel cable 5CAMPH.0xxx-00

3.3.2 Cable Specifications

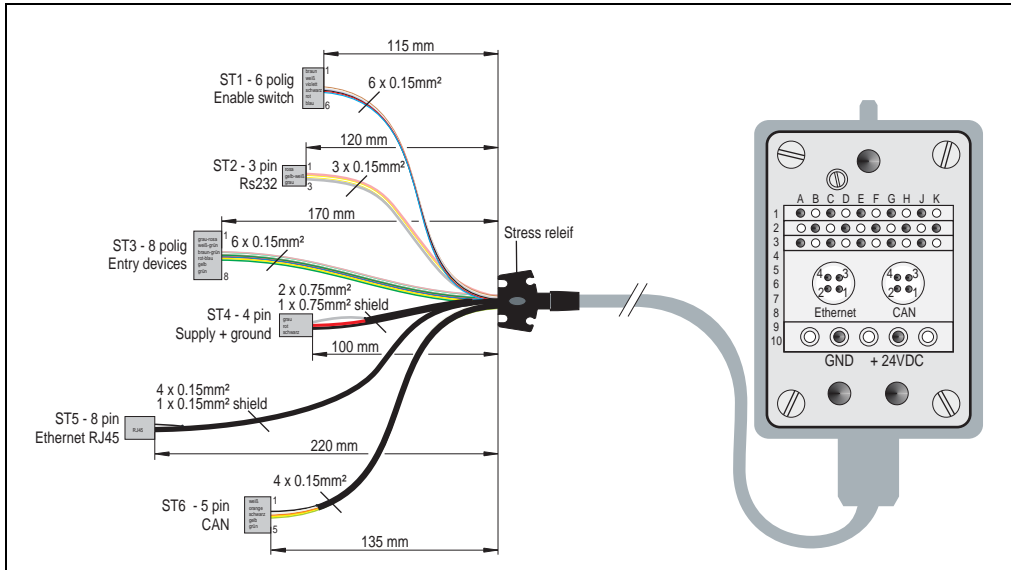

Figure 33: Connection cable specifications

ST1 Enable Switch, 6-pin Male Connector		Connection Cable Wire Colors	Socket Housing Assignment
C1	Pin 1	Brown	A1
NO1	Pin 2	White	A3
NC1	Pin 3	violet	B2
C2	Pin 4	Black	C1
NO2	Pin 5	Red	C3
NC2	Pin 6	Blue	D2
ST2 RS232, 3-pin Male Connector		Connection Cable Wire Colors	Socket Housing Assignment
RXD	Pin 1	Pink	J1
GND	Pin 2	White-Yellow	K2
TxD	Pin 3	Gray	J3
ST3 Entry Device, 8-pin Male Connector		Connection Cable Wire Colors	Socket Housing Assignment
E-stop normally closed contact 1 (11)	Pin 1	Gray-Pink	E1
E-stop normally closed contact 1 (12)	Pin 2	White-Green	E3
E-stop normally closed contact 2 (21)	Pin 3	Brown-Green	G1
E-stop normally closed contact 2 (22)	Pin 4	Red-Blue	G3
Key switch (13)	Pin 5	Yellow	F2
Key switch (14)	Pin 6	Green	H2
n.c.	Pin 7	-	-
n.c.	Pin 8	-	-

Technical Data • Individual Components

ST4 Supply		Connection Cable Wire Ccolors	Socket Housing Assignment
+24 VDC supply	Pin 1	Red	+24 VDC
Shielding	Pin 2	Gray	Plug housing (outer shield)
Ground	Pin 3	Black	GND
n.c.	Pin 4	-	-
ST5 Ethernet RJ45 Connector		Connection Cable Wire Ccolors	Socket Housing Assignment
TX	Pin 1	Green	Pin 1
TX	Pin 2	Yellow	Pin 4
RX	Pin 3	Pink	Pin 2
n.c.	Pin 4	-	-
n.c.	Pin 5	-	-
RX	Pin 6	Blue	Pin 3
n.c.	Pin 7	-	-
n.c.	Pin 8	-	-
Shielding	-	Shielding	Ethernet shield
ST6 CAN, 5-pin Male Connector		Connection Cable Wire Ccolors	Socket Housing Assignment
CAN 1 High	Pin 1	White	Pin 1
CAN 1 Low	Pin 2	Orange	Pin 4
Shielding	Pin 3	Black	CAN shield
CAN 2 High	Pin 4	Yellow	Pin 2
CAN 2 Low	Pin 5	Green	Pin 3

3.4 Switching Cabinet Cable Crossover

The pin assignments for the Ethernet plug (crossover) make it possible to connect directly to a B&R controller e.g. CP360 or to the first Ethernet connection (MDIX) on the B&R Ethernet Hub AC808 (Mod.No. 0AC808.9).

If a different Ethernet hub is being used, it must be able to support the crossover of the RX and TX lines.

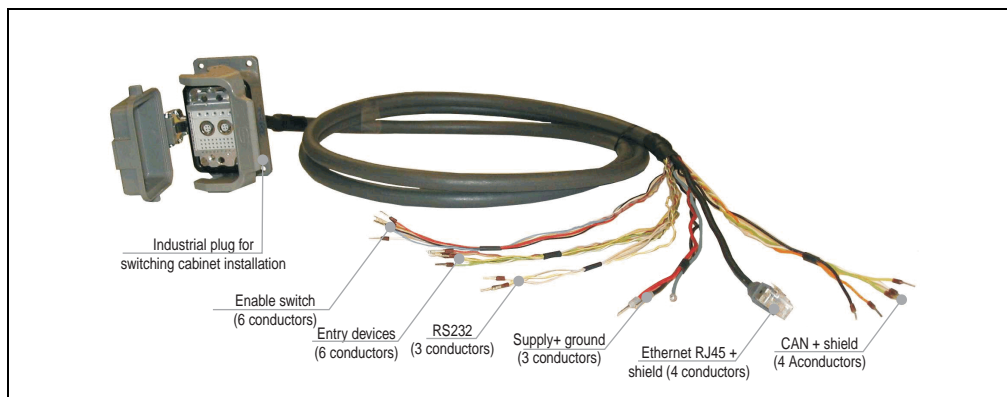

Figure 34: Mobile Panel switching cabinet cable 5CAMPC.0020-00

The switching cabinet cable is required for the wiring inside the switching cabinet.

The surface is protected against water, oil (protected against lubricating and hydraulic oils according to EN 60811 section 2-1) and cooling lubricant.

The connection housing is used to connect the switching cabinet cable to the switching cabinet door (see figure 36 "Drilling template for the switching cabinet socket" on Page 72). The other end of the switching cabinet cable has a pre-made RJ45 Ethernet plug. The rest of the lines have an open end with wire tip sleeves. This makes it easier to wire the cable to safety equipment and the other connections.

Information:

The seal, which is attached to the connection housing, must be placed between the connection housing and the switching cabinet door.

3.4.1 Shielding in the Switching Cabinet

The supply cable pair has a shield conductor (gray wire - see section 3.4.3 "Cable Specifications" on Page 70) which must be connected to an object in the switching cabinet with ground potential.

The CAN cable pair also has a shield conductor (black wire - see section 3.4.3 "Cable Specifications" on Page 70) that must be attached to the CAN bus shield.

Information:

The Ethernet plug has a shielding and can therefore only be connected to a socket which is also shielded.

3.4.2 Technical Data

Information:

The following characteristics, features and limit values are only valid for these individual components and can deviate from those for the entire device. For the entire device where, for example, these individual components are used, the data given for the entire device is valid.

Features	5CAMPC.0020-00
Length and Tolerance	2 meters ± 5 cm
Connector Industrial Socket	Connection housing with socket insert
Cables Total Diameter Weight per Meter Shielding Material Available Lengths Minimum Flex Radius Supply Lines Permissible Operating Voltage Material Conductor Resistance Maximum Tension Stress Color	Hybrid cable, 25 conductor 10 mm 153 grams Silicon and halogen free, flame retardant PUR outer sheathing See table 6 "Model numbers for Mobile Panel switching cabinet cables" on Page 19 60 mm 30 VDC Tinned copper wires ≤ 30 Ohm/km 140 N similar to RAL 7012
Cable Elements Network Enable Switch 2 x CAN Bus Entry Devices Power Supply Serial Connection (Rx/D, Tx/D)	Twisted pair cable for Ethernet (10/100 MBit/s) (4-wire) Direct connection between the enable switch and the monitoring device (6-wire) 2 pairs with shielding (5-wire) Direct connection between the entry device and the monitoring device (6-wire) Supply voltage 24 VDC and ground (3-wire) 3 Wires
Environment	
Permissible Operating Temperature Non-moving State Moving State	-20 °C to +80 °C -5 °C to +60 °C
Standards	Flame retardant in accordance with IEC 60332-1 and VW1 / FT1 in accordance with C-UL Shield damping in accordance with IEC 60096-1, amendment 2 Mechanical characteristics according to DIN VDE 0472 section 603 test type H (100000 cycles) Oil resistant, hydrolysis resistant according to DIN VDE 0282 section 10

Table 25: Technical data for the switching cabinet cable 5CAMPC.0020-00

3.4.3 Cable Specifications

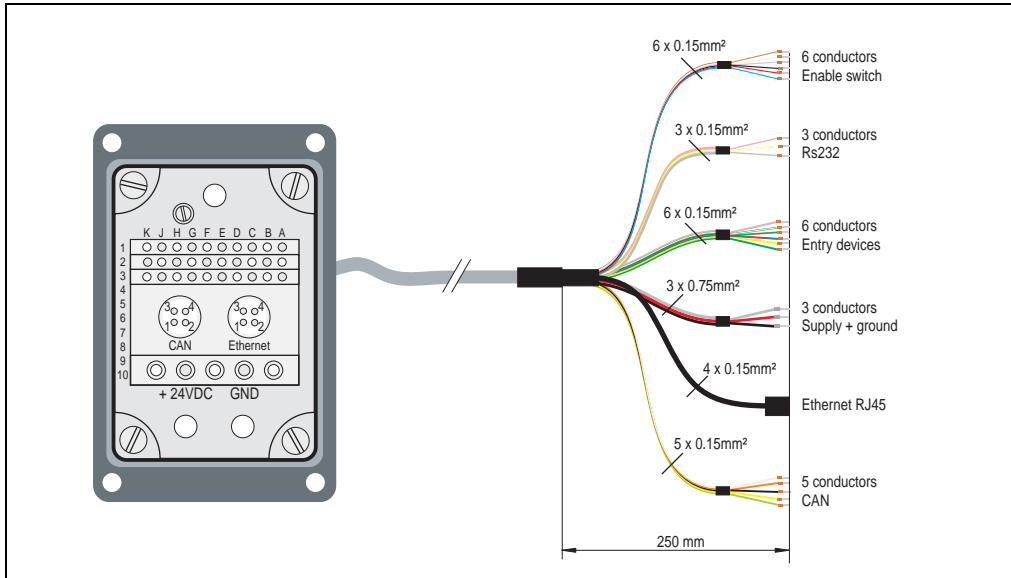

Figure 35: Cable layout for the switching cabinet cable

Connection Housing Assignment	Switching Cabinet Cable Wire Color	Enable Switch Wires
A1	Brown	C1
A3	White	NO1
B2	violet	NC1
C1	Black	C2
C3	Red	NO2
D2	Blue	NC2
Connection Housing Assignment	Switching Cabinet Cable Wire Color	RS232 Wires
J1	Pink	RxD
J3	Gray	TxD
K2	White-Yellow	GND
Connection Housing Assignment	Switching Cabinet Cable Wire Color	Entry Device Wires
E1	Gray-Pink	E-stop normally closed contact 1 (11)
E3	White-Green	E-stop normally closed contact 1 (12)
G1	Brown-Green	E-stop normally closed contact 2 (21)
G3	Red-Blue	E-stop normally closed contact 2 (22)
F2	Yellow	Key switch (13)
H2	Green	Key switch (14)

Connection Housing Assignment	Switching Cabinet Cable Wire Color	Supply Wires
GND	Black	Ground
+ 24 VDC	Red	+24 VDC supply
Plug housing (outer shield)	Gray	Shielding
Connection Housing Assignment	Switching Cabinet Cable Wire Color	Ethernet RJ45 Plug
Pin 1	Green	Pin 3 (RX)
Pin 2	Pink	Pin 1 (TX)
Pin 3	Blue	Pin 2 ($\overline{\text{TX}}$)
Pin 4	Yellow	Pin 6 ($\overline{\text{RX}}$)
Ethernet shield	Shielding	
Connection Housing Assignment	Switching Cabinet Cable Wire Color	CAN Wires
Pin 1	White	CAN 1 High
Pin 2	Yellow	CAN 2 High
Pin 3	Green	CAN 2 Low
Pin 4	Orange	CAN 1 Low
CAN shield	Black	Shielding

Information:

When installing the switching cabinet cable, make sure that it is not too loose or pulled too tight in the switching cabinet.

3.4.4 Drilling Template for the Connection Housing

A cutout and drill holes must be made according to the following diagram for mounting the connection housing (e.g. to a switching cabinet door).

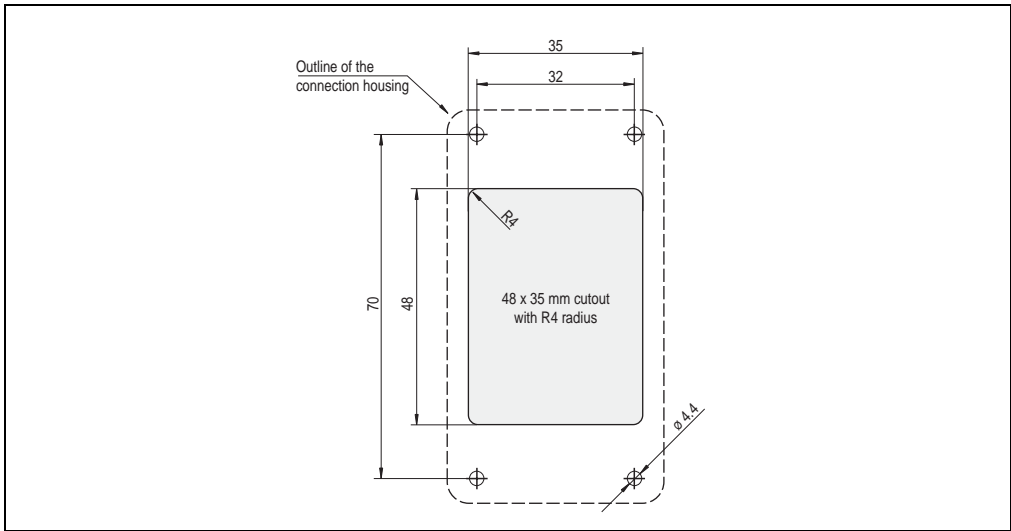

Figure 36: Drilling template for the switching cabinet socket

3.5 Switching Cabinet Cable - Straight Through

The pin assignments for the Ethernet plug (1:1) make it possible to connect directly to a standard Ethernet Hub.

If the first Ethernet connection on B&R Ethernet Hub AC808 (Mod.No. 0AC808.9) is used, make sure that the crossover (MDIX) is not activated.

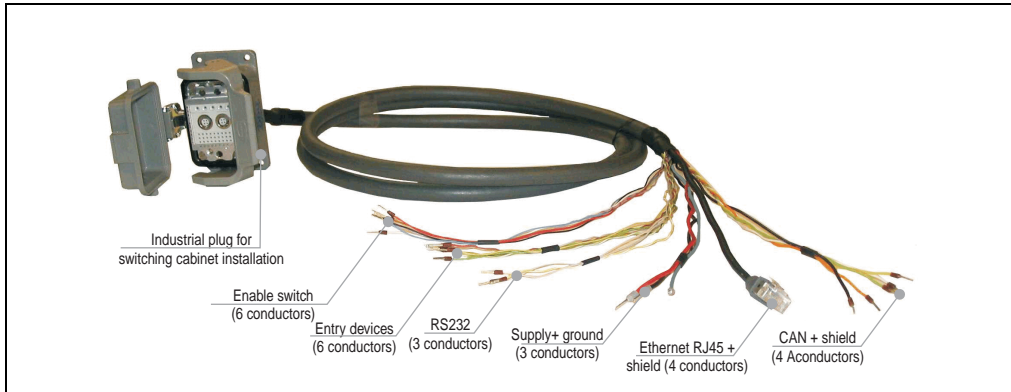

Figure 37: Mobile Panel switching cabinet cable 5CAMPC.0020-01

The switching cabinet cable is required for the wiring inside the switching cabinet.

The surface is protected against water, oil (protected against lubricating and hydraulic oils according to EN 60811 section 2-1) and cooling lubricant.

The connection housing is used to connect the switching cabinet cable to the switching cabinet door (see figure 39 "Drilling template for the switching cabinet socket" on Page 77). The other end of the switching cabinet cable has a pre-made RJ45 Ethernet plug. The rest of the lines have an open end with wire tip sleeves. This makes it easier to wire the cable to safety equipment and the other connections.

Information:

The seal, which is attached to the connection housing, must be placed between the connection housing and the switching cabinet door.

3.5.1 Shielding in the Switching Cabinet

The supply cable pair has a shield conductor (gray wire - see section 3.5.3 "Cable Specifications" on Page 75) which must be connected to an object in the switching cabinet with ground potential.

The CAN cable pair also has a shield conductor (black wire - see section 3.5.3 "Cable Specifications" on Page 75) that must be attached to the CAN bus shield.

Information:

The Ethernet plug has a shielding and can therefore only be connected to a socket which is also shielded.

3.5.2 Technical Data

Information:

The following characteristics, features and limit values are only valid for these individual components and can deviate from those for the entire device. For the entire device in which, for example, these individual components are used, the data given for the entire device is valid.

Features	5CAMPC.0020-01
Length and Tolerance	2 meters ± 5 cm
Connector Industrial Socket	Connection housing with socket insert
Cables Total Diameter Weight per Meter Shielding Material Available Lengths Minimum Flex Radius Supply Lines Permissible Operating Voltage Material Conductor Resistance Maximum Tension Stress Color	Hybrid cable, 25 conductor 10 mm 153 grams Silicon and halogen free, flame retardant PUR outer sheathing See table 6 "Model numbers for Mobile Panel switching cabinet cables" on Page 19 60 mm 30 VDC Tinned copper wires ≤ 30 Ohm/km 140 N similar to RAL 7012
Cable Elements Network Enable Switch 2 x CAN Bus Entry Devices Power Supply Serial Connection (Rx, Tx)	Twisted pair cable for Ethernet (10/100 MBit/s) (4-wire) Direct connection between the enable switch and the monitoring device (6-wire) 2 pairs with shielding (5-wire) Direct connection between the entry device and the monitoring device (6-wire) Supply voltage 24 VDC and ground (3-wire) 3 Wires
Environment	
Permissible Operating Temperature Non-moving State Moving State	-20 °C to +80 °C -5 °C to +60 °C
Standards	Flame retardant in accordance with IEC 60332-1 and VW1 / FT1 in accordance with C-UL Shield damping in accordance with IEC 60096-1, amendment 2 Mechanical characteristics according to DIN VDE 0472 section 603 test type H (100000 cycles) Oil resistant, hydrolysis resistant according to DIN VDE 0282 section 10

Table 26: Technical data for the switching cabinet cable 5CAMPC.0020-01

3.5.3 Cable Specifications

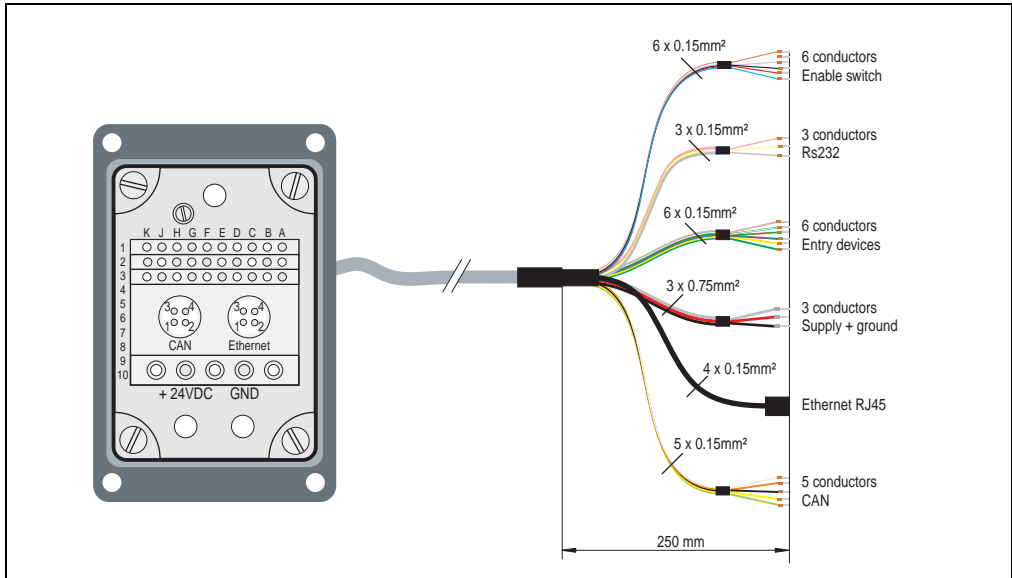

Figure 38: Cable layout for the switching cabinet cable

Connection Housing Assignment	Switching Cabinet Cable Wire Color	Enable Switch Wires
A1	Brown	C1
A3	White	NO1
B2	Violet	NC1
C1	Black	C2
C3	Red	NO2
D2	Blue	NC2
Connection Housing Assignment	Switching Cabinet Cable Wire Color	RS232 Wires
J1	Pink	RXD
J3	Gray	TxD
K2	White-Yellow	GND
Connection Housing Assignment	Switching Cabinet Cable Wire Color	Entry Device Wires
E1	Gray-Pink	E-stop normally closed contact 1 (11)
E3	White-Green	E-stop normally closed contact 1 (12)
G1	Brown-Green	E-stop normally closed contact 2 (21)
G3	Red-Blue	E-stop normally closed contact 2 (22)
F2	Yellow	Key switch (13)
H2	Green	Key switch (14)

Technical Data • Individual Components

Connection Housing Assignment	Switching Cabinet Cable Wire Color	Supply Wires
GND	Black	Ground
+ 24 VDC	Red	+24 VDC supply
Plug housing (outer shield)	Gray	Shielding
Connection Housing Assignment	Switching Cabinet Cable Wire Color	Ethernet RJ45 Plug
Pin 1	Green	Pin 1 (TX)
Pin 2	Pink	Pin 3 (RX)
Pin 3	Blue	Pin 6 (\overline{RX})
Pin 4	Yellow	Pin 2 (\overline{TX})
Ethernet shield	Shielding	
Connection Housing Assignment	Switching Cabinet Cable Wire Color	CAN Wires
Pin 1	White	CAN 1 High
Pin 2	Yellow	CAN 2 High
Pin 3	Green	CAN 2 Low
Pin 4	Orange	CAN 1 Low
CAN shield	Black	Shielding

Information:

When installing the switching cabinet cable, make sure that it is not too loose or pulled too tight in the switching cabinet.

3.5.4 Drilling Template for the Connection Housing

A cutout and drilling holes must be made according to the following diagram for mounting the connection housing (e.g. to a switching cabinet door).

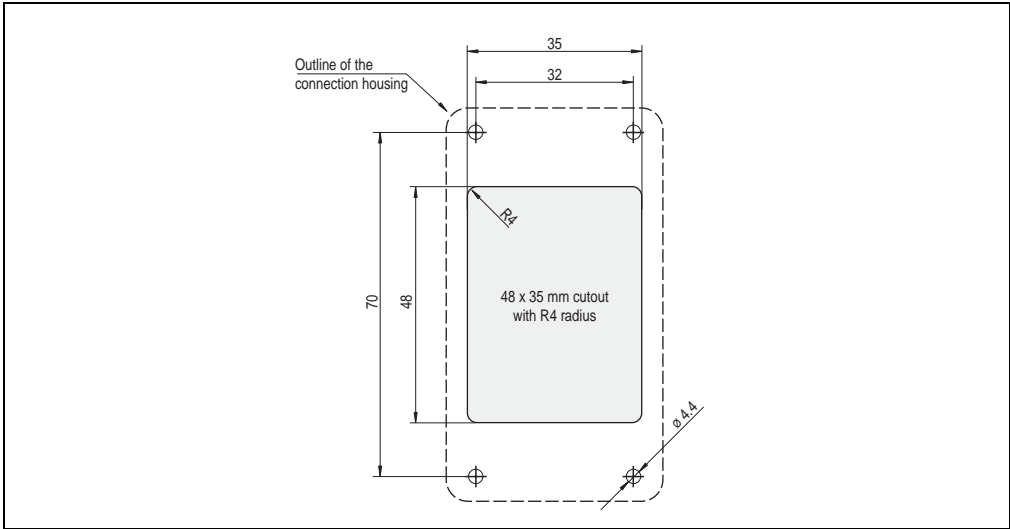

Figure 39: Drilling template for the switching cabinet socket

3.6 Wall Mount

The wall mount 4MPBRA.0000-00 is used for storing the Mobile Panel (operating unit + handle) together with the Mobile Panel connection cable and is only intended for upright, hanging installation.

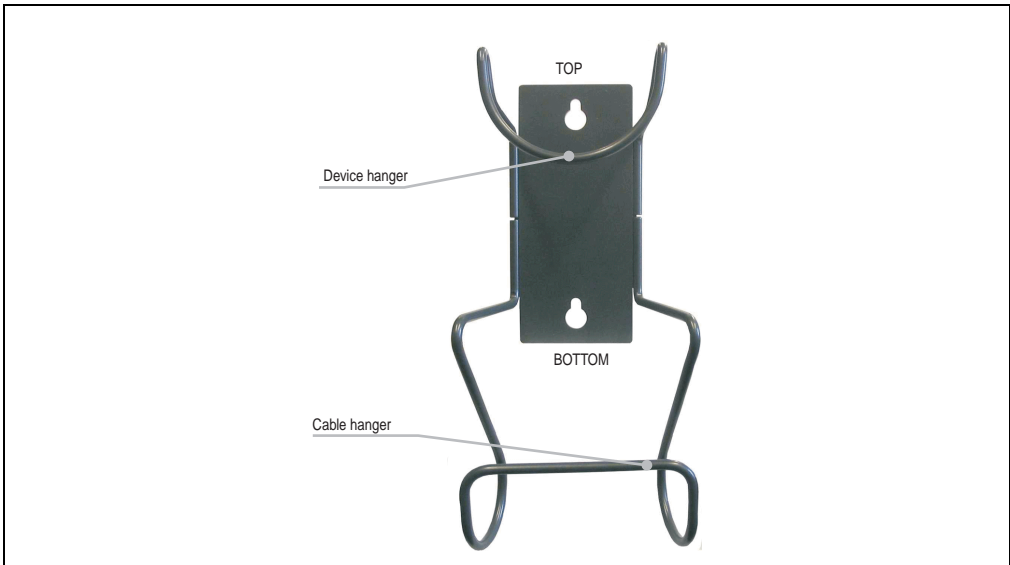

Figure 40: Wall Mount 4MPBRA.0000-00

Drilling holes for attaching the wall mount must be made in accordance with the diagram 41 "Wall mount 4MPBRA.0000-00 dimensions" on Page 79.

Caution!

The mounting location for the wall mount should be selected so that the Mobile Panel is not directly subjected to sources of heat or sunlight when placed on it. The wall mount should also be positioned so that operation of the E-stop is not impaired.

Danger!

When the Mobile Panel device is stored on its wall mount and located a in dangerous machine area, the connection cable and the switching cabinet cable must still be completely connected so that the E-stop button can be activated.

3.6.1 Technical Data

Mechanics	4MPBRA.0000-00
Material	St37
Paint, Color	Powder-coated (semi gloss), similar to RAL 7016
Dimensions (WxHxD)	140 x 305 x 109
Weight	680 grams

Table 27: Technical data 4MPBRA.0000-00

3.6.2 Dimensions

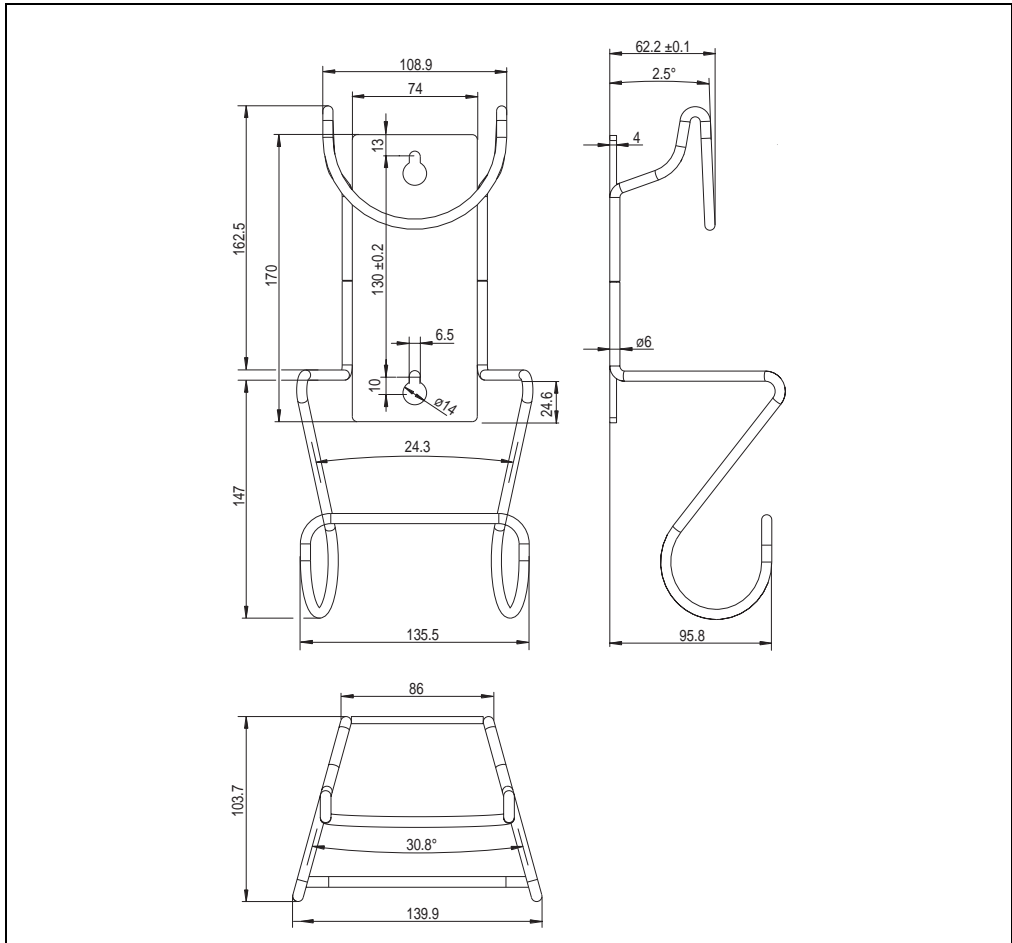

Figure 41: Wall mount 4MPBRA.0000-00 dimensions

3.6.3 Storing the Mobile Panel Device

The following images illustrate the proper method for storing the Mobile Panel device in the wall mount.



Table 28: Storing the Mobile Panel device in the wall mount

3.7 Strapping Plug

The strapping plug is used to bridge the E-stop contact on the switching cabinet in the event that the Mobile Panel becomes unplugged. This plug is connected to the connection housing on the switching cabinet cable.

3.7.1 Order Data

Model Number	Description	Image
4MPBYP.0000-00	Strapping plug	

Table 29: Strapping plug order data

3.7.2 Technical Data

Mechanics	4MPBYP.0000-00
Connector Industrial Connector	Connection housing with pin insert
Dimensions (WxHxD)	43 x 80 x 50
Weight	170 grams

Table 30: Technical data 4MPBYP.0000-00

3.7.3 Cable Layout

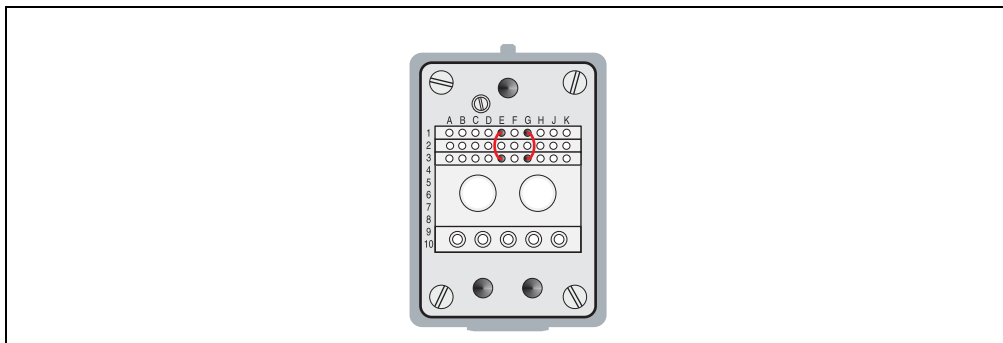

Figure 42: Cable layout for the strapping plug

In the strapping plug, both E-stop contacts **E1 - E3** as well as **G1 - G3** are connected with each other.

Information:

When using the strapping plug, the two contacts for the key switch (F2, H2) are not connected with each other. They must be wired externally. If the Mobile Panel device is reconnected with the switching cabinet cable using a connection cable, the key switch could be triggered at two different positions (Mobile Panel + external wiring)!

Chapter 3 • Start-up / Operation

1. Commissioning from a Safety Point of View

In order to put the Mobile Panel device into operation, the E-stop function must first be acknowledged using the key switch. This causes the E-stop safety relay to begin monitoring the E-stop button. If this is not operated and the enable switch is pressed in the enable position or a safety door on the system is closed, then the main circuit contact, which has to be effected via external mandatory safeguards, is closed.

When the E-stop button is actuated, it becomes engaged. The E-stop monitoring device then shuts down the machine or system. A quarter turn clockwise releases the E-stop button once again. Releasing the E-stop button may not cause the machine to automatically begin running again. The E-stop action must first be acknowledged with the key switch before the machine or system can be put back into operation. Bypassing the key switch will be detected by the monitoring device.

The machine's safety circuit remains interrupted as long as the 3-step enable switch has not been pressed or the assembly's safety door has not been closed. The enable switch has three steps, but the enable signal is only passed on when it's set in the middle position. In other words, the enable switch must be pressed to the middle position in order for the Mobile Panel to carry out user commands (see also "Functionality" in "Enable Switch", on page 60).

1.1 Intended Use

The Mobile Panel device may only be used for the applications described in section "Introduction", on page 21.

Information:

The responsibility for the correctness and functionality of the wiring, adherence to prescribed standards, and safety engineering rests solely with the project engineers.

2. Operating the Mobile Panel Device

Caution!

- Make sure that cables are safely out of the way on the floor to prevent any tripping which may result in the Mobile Panel device falling to the ground.
- The Mobile Panel connection cable may not be pinched or come into contact with sharp corners, which would result in damage to the cable or its sheathing.
- Operating a Mobile Panel with a damaged connection or switching cabinet cable is not permitted.
- When not using the Mobile Panel, it should be safely stowed away on its wall mount. When the Mobile Panel device is stored on its wall mount, the connection cable must still be connected so that the E-stop button can be activated in dangerous machine areas.
- When laying down the Mobile Panel device for a short period of time, do not place it in such a way that its entry device could be damaged or where it may inadvertently trigger an action. Also, do not place it on unstable surfaces where it may fall. It should never be placed near heat sources or in direct sunlight.
- Although the Mobile Panel device has been designed for use in harsh industrial environments, it should still not come into contact with large amounts of dust or humidity, excessive mechanical shocks, or strong magnetic fields.
- The touch screen may not be operated with sharp objects such as ballpoint pens, knives, screwdrivers, etc. These objects will permanently damage the touch screen. The ideal object for operating the touch screen is the touch screen pen (see "Touch Screen Pen", on page 30). Operating the touch screen with a finger is also allowed.
- When operating the touch screen, only one point at a time be touched. Touching several places at once can cause unintended actions.
- Do not place object on top of the touch screen.
- If the Mobile Panel device has sustained a severe shock (e.g. if it has fallen), then the CF / USB cover fitting must be checked directly afterwards. If a Compact Flash card had been inserted into the Compact Flash slot at the time of impact, then this fitting must be checked as well. The safety features on the Mobile Panel must also be inspected (E-stop button, key switch, enable switch).

Caution!

Pressing several function or system keys at the same time may trigger unintended actions.

Information:

- Protective coverings on the device, housing screws, and damage to the housing and cables should all be checked periodically.
- For instructions on cleaning the Mobile Panel device, see "Cleaning", on page 135.

3. Recommended Monitoring Devices

B&R recommends using PNOZ e1.1p or PNOZ e2.1p safety relays from the Pilz company (www.pilz.com) in order to achieve Safety Category 4 in accordance with EN 954-1. As a monitoring device for the E-stop button, the PNOZ e1.1p can be used for safety circuits up to Safety Category 4 according to EN 954-1. It is imperative to use the PNOZ e2.1p as a monitoring device for the enable switch for safety circuits up to Category 4 (EN 954-1).

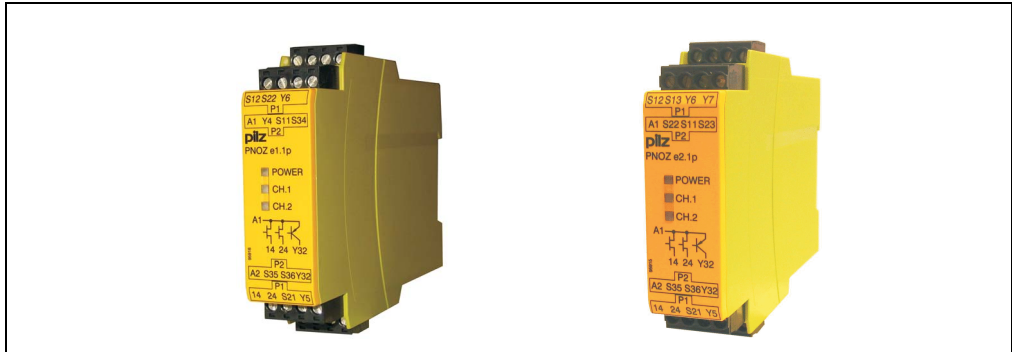

Figure 43: Pilz PNOZ e1.1p (left) and Pilz PNOZ e2.1p (right)

Warning!

If EN 954-1 Safety Categories 2, 3, and 4 are not necessary, safeguards can be switched directly on the E-stop circuit for Categories B and 1. When doing so, be aware of EN 954-1 and EN ISO 13849-2 guidelines as well as the max. permitted current load on the E-stop button and the key switch! More information can be found in the section 3.3 "Current Load of the Enable Switch and Entry Device Circuit" on Page 92.

3.1 Connection Examples for the E-stop and Key Switch

Warning!

The highest safety category that can be reached for an entire system is always determined by the lowest safety circuit category being used.

3.1.1 Connection Example for Safety Circuits up to EN 954-1 Category 4

This circuit has two channels which monitor starts and detects short circuits and ground faults. Errors in the safety circuit, and errors or short circuits in the E-stop button are recognized.

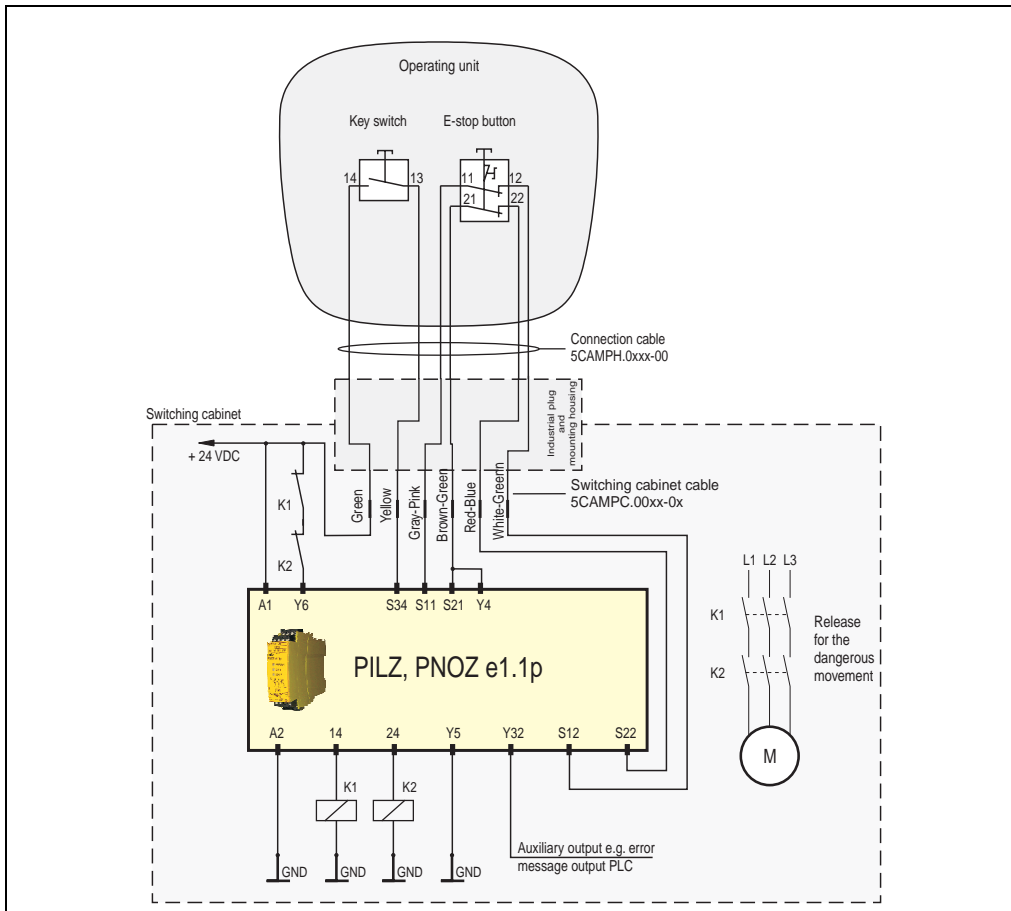

Figure 44: Connection example for safety circuits up to EN 954-1 Category 4

Warning!

All K1 and K2 contacts must be positively driven.

Danger!

To guarantee EN418 and Safety Category 4 accordance with EN 954-1, the instructions for the monitoring device being used must be followed.

3.1.2 Connection Example for Safety Circuits up to EN 954-1 Category 1

This switch has one channel. Ground faults are recognized.

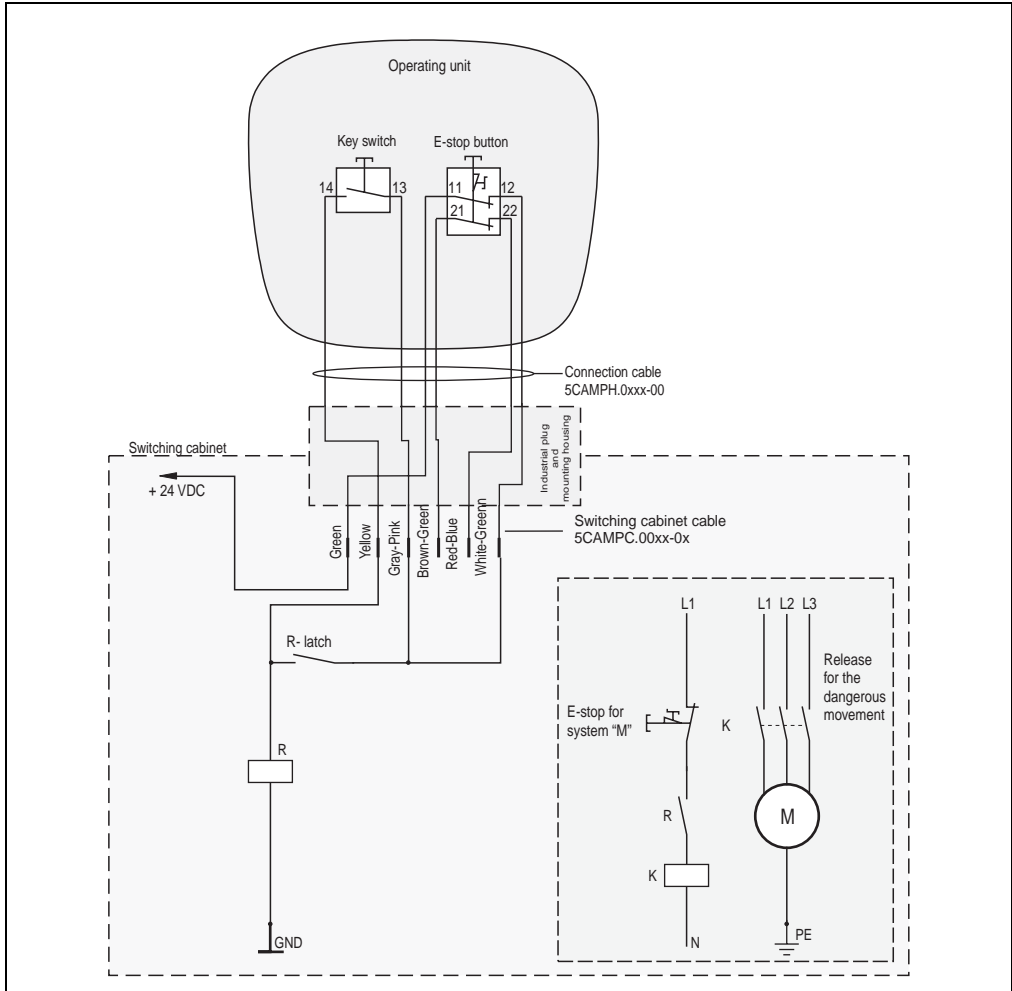

Figure 45: Connection example for safety circuits up to EN 954-1 Category 1

Warning!

Pay attention to the max. permitted current load of the E-stop button, the key switch, and the enable switch! More information can be found in the section 3.3 "Current Load of the Enable Switch and Entry Device Circuit" on Page 92.

The Mobile Panel device should never be operated while the functions which protect the Mobile Panel device are out of order!

3.2 Connection Example for the Enable Switch

Warning!

The highest safety category that can be reached for an entire system is always determined by the lowest safety circuit category being used.

3.2.1 Connection Example for Safety Circuits up to EN 954-1 Category 4

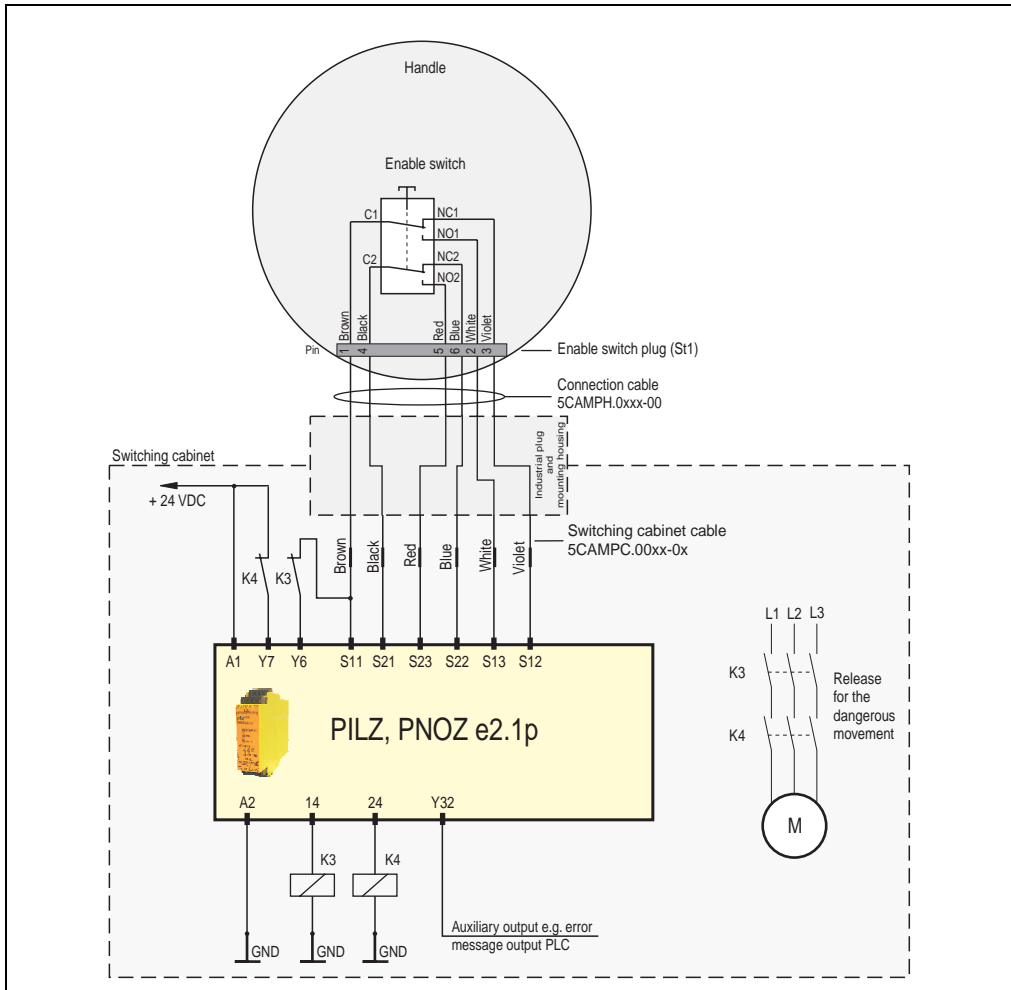

Figure 46: Connection example for using in safety circuits up to Category 4 in accordance with EN 954-1 with Pilz PNOZ e2.1p safety relay (with cross connection detection and simultaneous operation monitoring)

Warning!

All K3 and K4 contacts must be positively driven.

Danger!

To guarantee EN418 and Safety Category 4 accordance with EN 954-1, the instructions for the monitoring device being used must be followed.

3.3 Current Load of the Enable Switch and Entry Device Circuit

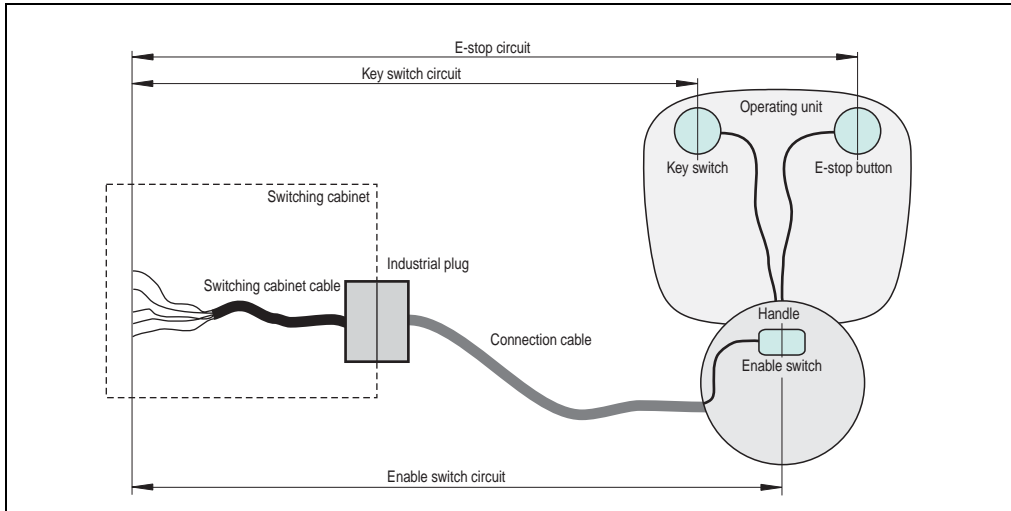

Figure 47: Current load of the enable switch and entry device circuit

The limit values in the following table result from the different current loads of the components in the enable switch and entry device circuit (circuit boards, cables, buttons, etc.). These values apply beginning from the start of the cable in the switching cabinet (switching cabinet cable) to the respective safety feature or unit (key switch, E-stop button, and enable switch) on the operator panel or handle.

	Max. current load	Max. voltage
E-stop circuit	0.4 A	32 VDC
Key switch circuit	0.1 A	32 VDC
Enable switch circuit (adhere to Category AC12/DC12)	0.4 A	30 VDC

Table 31: Current load of the enable switch and entry device circuit

Information:

If wanting to use an additional fuse to protect a circuit, then the following fuse types should be used for the respective circuits:

E-stop circuit: 0.4 A slow-blow glass tube fuse

Key switch circuit: 0.1 A slow-blow glass tube fuse

Enable switch circuit: 0.4 A slow-blow glass tube fuse

Chapter 4 • Software

1. Mobile Panel with Automation Runtime

1.1 General Information

B&R Automation Runtime guarantees a uniform runtime environment for Automation Studio programs on all target systems. This assures uniform programming and operation on all devices.

Automation Runtime™ possesses a multitasking operating system adapted especially for use with control technology. The cycle time for your application can be separated among several task classes. Automation Runtime ensures that all application programs are executed within defined time periods, proving itself to be a configurable, deterministic real-time multitasking system.

An extensive project can be divided into small individual tasks. This way of working increases modularity and makes it much easier to maintain projects.

1.2 Control and Visualization with the Mobile Panel

Both the control program and the visualization application run on the Mobile Panel. I/O peripherals and drives are connected via the CAN bus. Communication to higher-level systems is handled by Ethernet.

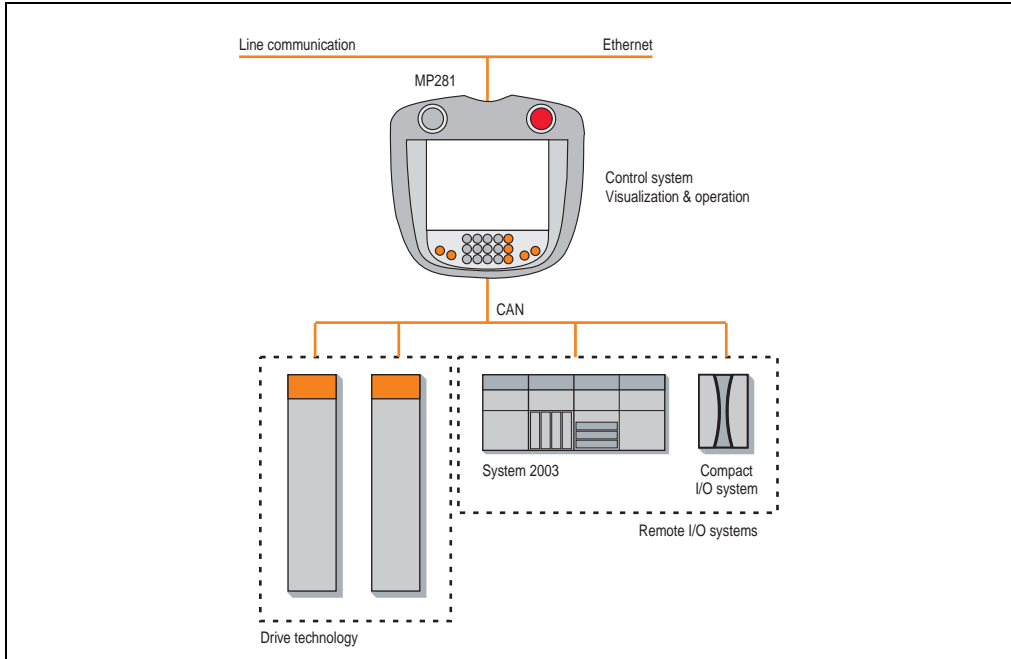

Figure 48: Control and visualization with the Mobile Panel

1.3 Operation and Monitoring with the Mobile Panel

Control programs are distributed and run over several PLC stations. Fieldbus systems are used to connect I/O systems and drives to the PLCs. Machine operation and visualization take place on a central Mobile Panel, which uses Ethernet to communicate with the controllers.

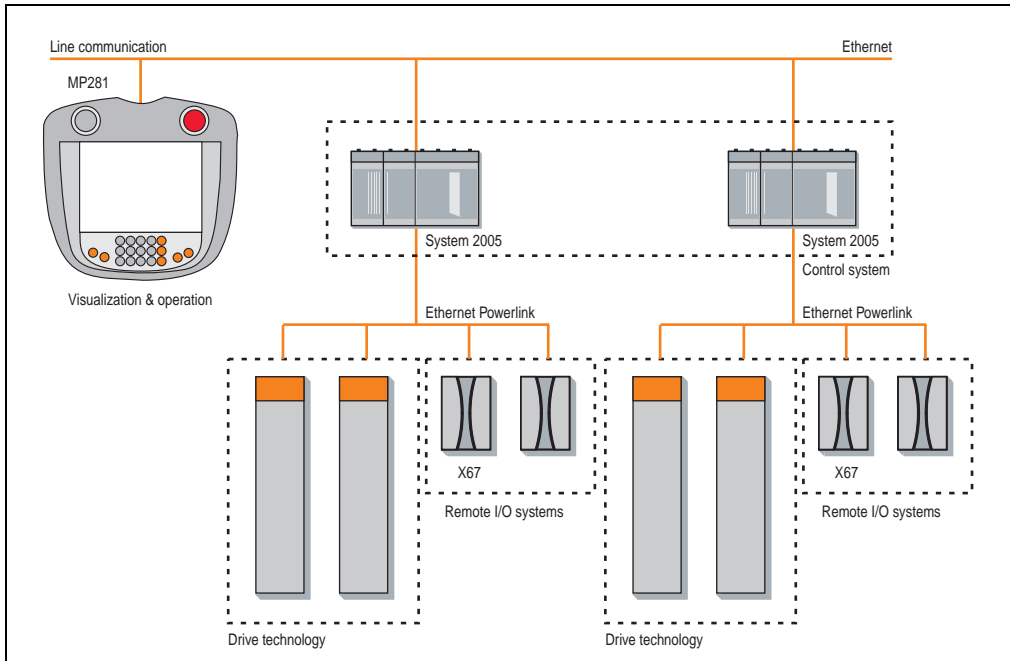

Figure 49: Operation and monitoring with the Mobile Panel

1.4 Summary Screen

When the Mobile Panel device is turned on, a summary screen is briefly displayed which shows the parameters most important to an Automation Runtime Mobile Panel device.

Information:

The following image and description refer only to Automation Runtime V2.66. For this reason, this image may not match with Automation Runtime version installed on your device.

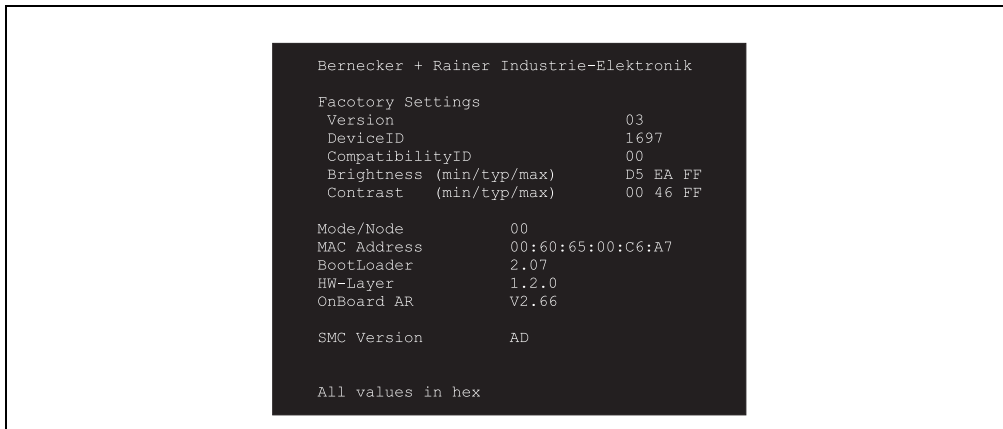

Figure 50: Automation Runtime summary screen

Information	Example value	Description
Version	03	Displays the factory settings version. These factory settings determine the device ID, display ID, display-specific initialization sequences, and other important parameters. Information: Factory settings are set by B&R and cannot be changed by the user!
DeviceID	1697	Displays the hexadecimal value of the hardware device number.
CompatibilityID	00	Displays the version of the device within the same B&R device code. This ID is needed for Automation Runtime.
Brightness (min / typ / max)	D5 EA FF	Displays the minimum, typical, and maximum values for the brightness settings of the display as hexadecimal values.
Contrast (min / typ / max)	00 46 FF	Displays the minimum, typical, and maximum values for the contrast settings of the display as hexadecimal values.
Mode/Node	00	Displays the current operating mode switch positions.
MAC Address	00:60:65:00:C6:A7	Displays the assigned media access control (MAC) address.
BootLoader	2.07	Displays the version of the boot loader.
HW-Layer	1.2.0	Displays the version of the hardware layer.
Onboard AR	V2.66	Displays the current onboard Automation Runtime version.
SMC Version	AD	Displays the current SMC (system management controller) software version.

Table 32: Automation Runtime summary screen

2. Mobile Panel with Windows CE



2.1 General Information

Windows CE is an operating system which is optimally tailored to B&R's Mobile Panel device. It includes only the functions and modules which are required by each device. This makes this operating system extremely robust and stable.

Advantages

- Windows CE is a 32-bit operating system with multitasking and multithreading capabilities.
- In addition to being compact, it even offers high performance for configurations with limited RAM.
- Windows CE is best suited for integrated automation used in industrial systems.
- Windows CE is also less expensive than other Windows licenses.

The Windows CE version available from B&R has been developed for Mobile Panel BIOS devices and is only available with a Mobile Panel BIOS device.

2.2 Requirements

The Mobile Panel device must meet the following criteria to run the Windows CE operating system.

- Mobile Panel device with BIOS
- At least 128 MB SDRAM main memory

2.3 Installation

Windows CE is usually preinstalled at B&R Austria.

2.4 Serial ActiveSync Connection

In order to establish a serial connection between a Mobile Panel CE device and a desktop PC, an RS232 cable needs to be connected correctly.

Information:

Serial ActiveSync connections are offered on Mobile Panel devices beginning with Revision C0.

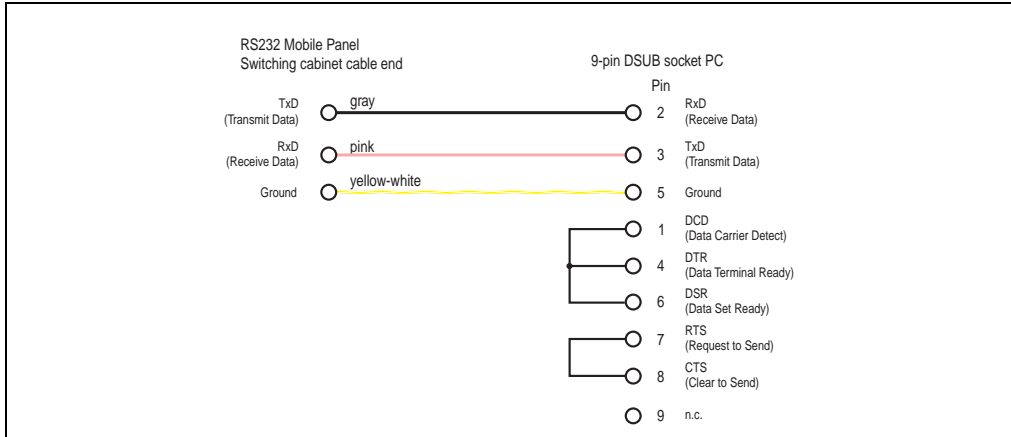

Figure 51: Directions for establishing an ActiveSync connection

The three ends of the RS232 Mobile Panel switching cabinet cable (grey, pink, and yellow-white) must be connected to a 9-pin DSUB socket as shown in the above image. Some of the pins of the 9-pin DSUB socket must be connected with each other as well.

Additional information can also be found in the B&R Windows CE help system.

2.5 Mobile Panel as a Thin Client

The Mobile Panel with the Windows CE operating system is connected as a thin client to an industrial PC with Windows XP Professional/Embedded via Ethernet. The control program runs on the industrial PC, and I/O peripherals and drives are connected to the industrial PC via a fieldbus.

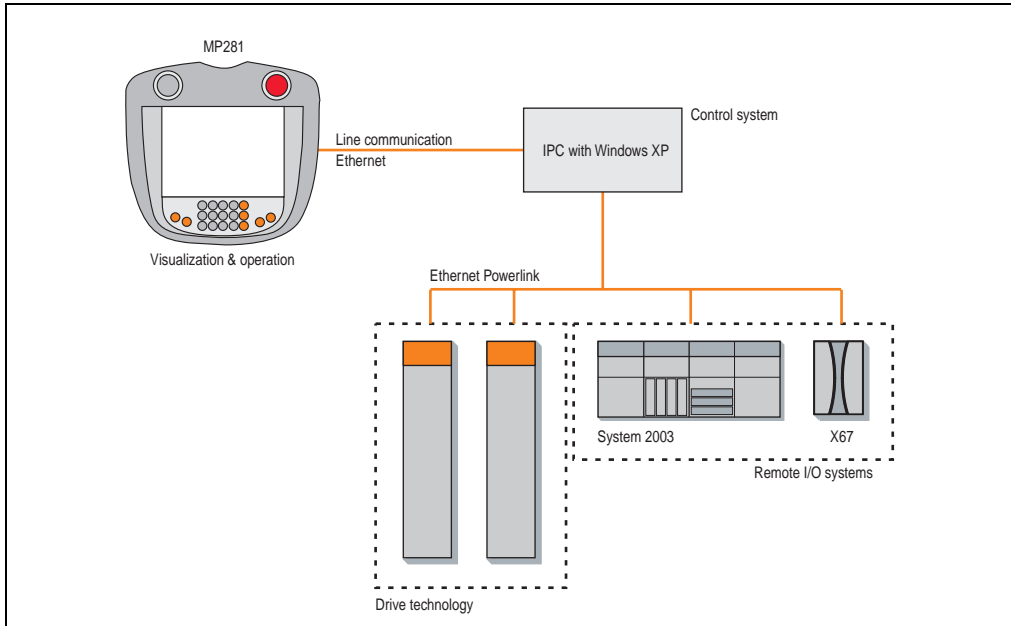

Figure 52: Mobile Panel as a thin client

3. Mobile Panel with Windows XP Embedded



3.1 General Information

Windows XP Embedded is the most modularized version of the Windows XP Professional desktop operating system and makes it possible to quickly develop reliable and advanced embedded devices. Windows XP Embedded is based on the same binary files as Windows XP Professional and is optimally tailored to the hardware being used. In other words, only the functions and modules which are required by the respective device are included. Windows XP Embedded is also based on the same reliable code as Windows XP Professional. It provides industry with leading reliability, improvements in security and performance, and the latest technology for Web browsing and extensive device support.

The Windows XP Embedded version available from B&R has been developed for Mobile Panel BIOS devices and is only available with a Mobile Panel BIOS device.

3.2 Requirements

The Mobile Panel device must meet the following criteria to run the Windows XP Embedded operating system.

- Mobile Panel device with BIOS
- At least 128 MB RAM

3.3 Installation Procedures

Windows XP Embedded is usually preinstalled at B&R Austria on a suitable Compact Flash card (256 MB). The Mobile Panel device is then automatically configured after it has been switched on for the first time. This procedure takes approximately 30 minutes, and the device will be rebooted a number of times.

A short guide to creating individual Windows XP Embedded images and a suitable Target Designer export file for Mobile Panel BIOS devices can be found on the HMI Drivers & Utilities CD-ROM (model number 5S0000.01-090 for version 1.49 or higher) or directly downloaded from the B&R homepage (www.br-automation.com).

Chapter 5 • Standards and Certifications

1. Valid European Guidelines

- EMC guidelines 89/336/EWG
- Low-voltage guidelines 73/23/EWG
- Machine guidelines 98/37/EG

2. Overview of Standards

Standard	Description
EN 418	Safety of machines, E-stop equipment, functional aspects, design principles
EN 50081-1	Electromagnetic compatibility (EMC), Generic standard - emission standard - Part 1: Living area, shops and small businesses, (EN 50081-1 has been replaced by EN 61000-6-3 and can be used until 01.07.2004)
EN 50081-2	Electromagnetic compatibility (EMC), Generic standard - emission standard - Part 2: Industrial environments, (EN 50081-2 will be replaced by EN 61000-6-4 and can still be used until 01.07.2004)
EN 50082-1	Electromagnetic compatibility (EMC), Generic standard - immunity standard - Part 1: Living area, shops and small businesses, (EN 50082-1 was replaced by EN 61000-6-1)
EN 50082-2	Electromagnetic compatibility (EMC) - Generic standard - immunity standard - Part 2: Industrial environments, (EN 50082-2 has been replaced by EN 61000-6-2)
EN 55011 Class A	Electromagnetic compatibility (EMC), radio disturbance product standard, industrial, scientific and medical high-frequency devices (ISM devices), limit values and measurement procedure; group 1 (devices that do not create HF during material processing) and group 2 (devices that create HF during material processing)
EN 55022 Class A	Electromagnetic compatibility (EMC) - radio disturbance characteristics product standard; information technology equipment (ITE devices), limit values and measuring procedure
EN 55024 Class A	Electromagnetic compatibility (EMC), immunity to disturbances product standard; information technology equipment (ITE devices), limit values and measuring procedure
EN 60068-2-1	Environmental testing - Section 2: Tests; Test group A: Cooling
EN 68068-2-2	Environmental testing - Section 2: Tests; Test group B: Dry heat
EN 60068-2-3	Environmental testing - Section 2: Testing; test and guideline: Moist heat, constant
EN 60068-2-6	Environmental testing - Section 2: Tests; test: Oscillation, sinusoidal
EN 60068-2-14	Environmental testing - Section 2: Tests; test N: Temperature Change
EN 60068-2-27	Environmental testing - Section 2: Testing; test and guideline: Shocks
EN 60068-2-30	Environmental testing - Section 2: Testing; test and guideline: Moist heat, cyclical

Table 33: Overview of standards

Standards and Certifications • Overview of Standards

Standard	Description
EN 60068-2-31	Environmental testing - Section 2: Tests; test: Toppling and knocking over, mainly for devices
EN 60068-2-32	Environmental testing - Section 2: Tests; test: Free falling
EN 60204-1	Safety of machinery, electrical equipment on machines - Part 1: General requirements
EN 60721-1	Classification of environmental conditions - Section 1: Preferred values for variables
EN 60721-3-2	Classification of environmental conditions - Section 3: Classes of environmental variables and their limits, section 2: Transport
EN 60721-3-3	Classification of environmental conditions - Section 3: Classes of environmental variables and their limits, section 3: Fixed location use, weather-protected
EN 61000-4-2	Electromagnetic compatibility (EMC) - Section 4-2: Testing and measuring procedure; testing the immunity against discharge of static electricity
EN 61000-4-3	Electromagnetic compatibility (EMC) - Section 4-3: Testing and measuring procedure; testing immunity to high frequency electromagnetic fields
EN 61000-4-4	Electromagnetic compatibility (EMC) - Section 4-4: Testing and measuring procedure; testing the immunity to fast transient electrical disturbances/burst
EN 61000-4-5	Electromagnetic compatibility (EMC) - Section 4-5: Testing and measuring procedure; testing immunity to surge voltages
EN 61000-4-6	Electromagnetic compatibility (EMC) - Section 4-6: Testing and measuring procedure; immunity to conducted disturbances, induced by high-frequency fields
EN 61000-4-8	Electromagnetic compatibility (EMC) - Section 4-8: Testing and measuring procedure; testing the immunity against magnetic fields with energy technology frequencies
EN 61000-4-11	Electromagnetic compatibility (EMC) - Section 4-11: Testing and measuring procedure; testing the immunity against voltage dips, short-term interruptions and voltage fluctuations
EN 61000-4-12	Electromagnetic compatibility (EMC) - Section 4-12: Testing and measuring procedure; testing immunity to damped oscillation
EN 61000-6-1 (EN 50082-1)	Electromagnetic compatibility (EMC), Generic standard - immunity standard - Part 1: Living areas, shops and small businesses (EN 50082-1 was replaced by EN 61000-6-1)
EN 61000-6-2 (EN 50082-2)	Electromagnetic compatibility (EMC) - Generic standard - immunity standard - Part 2: Industrial environment, (EN 50082-2 has been replaced by EN 61000-6-2)
EN 61000-6-3 (EN 50081-1)	Electromagnetic compatibility (EMC), Generic standard - emission standard - Part 1: Living areas, shops and small businesses (EN 50081-1 has been replaced by EN 61000-6-3 and can be used until 01.07.2004)
EN 61000-6-4 (EN 50081-2)	Electromagnetic compatibility (EMC), Generic standard - emission standard - Part 2: Industrial environment, (EN 50081-2 will be replaced by EN 61000-6-4 and can still be used until 01.07.2004)
EN 61131-2 IEC 61131-2	Product standard, Programmable logic controllers - Part 2: Equipment requirements and tests
EN 61508-1	Functional safety safety related electrical/electronic/programmable electronic systems - Part 1: General requirements
EN 61508-2	Functional safety safety related electrical/electronic/programmable electronic systems - Part 2: Demands on safety related electrical/electronic/programmable electronic systems
EN 954-1	Safety of machinery - safety-related parts of control systems <ul style="list-style-type: none"> • Part 1: General design principles ¹⁾
UL 508	Industrial Control Equipment, (UL = Underwriters Laboratories)

Table 33: Overview of standards (cont.)

1) Government safety organization: The sample test for the category 4 E-stop and enable switch parts according to EN 954-1 is in preparation.

3. Requirements for Emissions (Emission)

Emission	Test carried out according to	Limit values according to
Network related emissions	EN 55011 / EN 55022	EN 61000-6-4: Generic standard (industrial area)
		EN 55011: Industrial product standard, scientific and medical high-frequency devices (ISM devices) class A (industrial area)
		EN 55022: Product standard equipment for Information Technology (ITE devices) class A (industrial area)
		EN 61131-2: Product standard programmable logic controller
Electromagnetic Emissions	EN 55011 / EN 55022	EN 61000-6-4: Generic standard (industrial area)
		EN 55011: Industrial product standard, scientific and medical high-frequency devices (ISM devices) class A (industrial area)
		EN 55022: Product standard equipment for Information Technology (ITE devices) class A (industrial area)
		EN 61131-2: Product standard programmable logic controller
		47 CFR Part 15 Subpart B class A (FCC)

Table 34: Overview of limits and testing guidelines for emission

3.1 Network Related Emissions

Test carried out according to EN 55011 / EN 55022	Limit values according to EN 61000-6-3	Limit values according to EN 55011 class A	Limit values according to EN 55022 class A
Power Mains Connections 150 kHz - 500 kHz	79 dB (µV) Quasi-peak Value 66 dB (µV) Average	79 dB (µV) Quasi-peak Value 66 dB (µV) Average	79 dB (µV) Quasi-peak Value 66 dB (µV) Average
Power Mains Connections 500 kHz - 30 MHz	73 dB (µV) Quasi-peak Value 60 dB (µV) Average	73 dB (µV) Quasi-peak Value 60 dB (µV) Average	73 dB (µV) Quasi-peak Value 60 dB (µV) Average
Other Connections 150 kHz - 500 kHz	97 - 87 dB (µV) and 53 - 43 dB (µA) Quasi-peak Value 84 - 74 dB (µV) and 40 - 30 dB (µA) Average	97 - 87 dB (µV) and 53 - 43 dB (µA) Quasi-peak Value 84 - 74 dB (µV) and 40 - 30 dB (µA) Average	97 - 87 dB (µV) and 53 - 43 dB (µA) Quasi-peak Value 84 - 74 dB (µV) and 40 - 30 dB (µA) Average
Other Connections 500 kHz - 30 MHz	87 dB (µV) and 43 dB (µA) Quasi-peak Value 74 dB (µV) and 30 dB (µA) Average	87 dB (µV) and 43 dB (µA) Quasi-peak Value 74 dB (µV) and 30 dB (µA) Average	87 dB (µV) and 43 dB (µA) Quasi-peak Value 74 dB (µV) and 30 dB (µA) Average
Test carried out according to EN 55011 / EN 55022	Limit values according to EN 61131-2		
Power Mains Connections ¹⁾ 150 kHz - 500 kHz	79 dB (µV) Quasi-peak Value 66 dB (µV) Average		

Table 35: Test requirement network related emission industrial area

Standards and Certifications • Requirements for Emissions (Emission)

Power Mains Connections 500 kHz - 30 MHz	73 dB (µV) Quasi-peak Value 60 dB (µV) Average		
Other Connections 150 kHz - 500 kHz	-		
Other Connections 500 kHz - 30 MHz	-		

Table 35: Test requirement network related emission industrial area (cont.)

1) With EN 61131-2 only AC network connections.

3.2 Electromagnetic Emissions

Test carried out according to EN 55011 / EN 55022	Limit values according to IEC 61000-6-4	Limit values according to EN 55011 class A	Limit values according to EN 55022 class A
30 MHz - 230 MHz Measured in 10 m distances	< 40 dB (µV/m) Quasi-peak Value	< 40 dB (µV/m) Quasi-peak Value	< 40 dB (µV/m) Quasi-peak Value
230 MHz - 1 GHz Measured in 10 m distances	< 47 dB (µV/m) Quasi-peak Value	< 47 dB (µV/m) Quasi-peak Value	< 47 dB (µV/m) Quasi-peak Value
Test carried out according to EN 55011 / EN 55022	Limit values according to EN 61131-2		
30 MHz - 230 MHz Measured in 10 m distances	< 40 dB (µV/m) Quasi-peak Value		
230 MHz - 1 GHz Measured in 10 m distances	< 47 dB (µV/m) Quasi-peak Value		

Table 36: : Test requirement electromagnetic emissions industrial area

4. Requirements for Immunity to Disturbances (Immunity)

Immunity	Test carried out according to	Limit values according to
Electrostatic discharge (ESD)	EN 61000-4-2	EN 61000-6-2: Generic standard (industry)
		EN 61131-2: Product standard programmable logic controller
		EN 55024: Product standard equipment for Information Technology (ITE devices)
Immunity to high-frequency electromagnetic fields (HF field)	EN 61000-4-3	EN 61000-6-2: Generic standard (industry)
		EN 61131-2: Product standard programmable logic controller
		EN 55024: Product standard equipment for Information Technology (ITE devices)
Immunity to high-speed transient electrical disturbances (Burst)	EN 61000-4-4	EN 61000-6-2: Generic standard (industry)
		EN 61131-2: Product standard programmable logic controller
		EN 55024: Product standard equipment for Information Technology (ITE devices)
Immunity to surge voltages (Surge)	EN 61000-4-5	EN 61000-6-2: Generic standard (industry)
		EN 61131-2: Product standard programmable logic controller
		EN 55024: Product standard equipment for Information Technology (ITE devices)
Immunity to conducted disturbances	EN 61000-4-6	EN 61000-6-2: Generic standard (industry)
		EN 61131-2: Product standard programmable logic controller
		EN 55024: Product standard equipment for Information Technology (ITE devices)
Immunity against magnetic fields with energy technical frequencies	EN 61000-4-8	EN 61000-6-2: Generic standard (industry)
		EN 61131-2: Product standard programmable logic controller
		EN 55024: Product standard equipment for Information Technology (ITE devices)
Immunity to voltage dips, short-term interruptions and voltage fluctuations	EN 61000-4-11	EN 61000-6-2: Generic standard (industry)
		EN 61131-2: Product standard programmable logic controller
		EN 55024: Product standard equipment for Information Technology (ITE devices)
Immunity to damped oscillations	EN 61000-4-12	EN 61000-6-2: Generic standard (industry)
		EN 61131-2: Product standard programmable logic controller
		EN 55024: Product standard equipment for Information Technology (ITE devices)

Table 37: Overview of limits and testing guidelines for immunity

Evaluation criteria according to EN 61000-6-2

Criteria A:

The operating equipment must continue to work as directed **during** the test. There should be no interference in the operating behavior and no system failures below an minimum operating quality as defined by the manufacturer.

Criteria B:

The operating equipment must continue to work as directed **after** the test. There should be no interference in the operating behavior and no system failures below an minimum operating quality as defined by the manufacturer.

Criteria C:

A temporary function failure is permitted when the function restores itself, or the function can be restored by activating configuration and control elements.

Criteria D:

Reduction or failure of the function, which can no longer be established (operating equipment destroyed).

4.1 Electrostatic Discharge (ESD)

Test carried out according to EN 61000-4-2	Limit values according to EN 61000-6-2	Limit values according to EN 61131-2	Limit values according to EN 55024
Contact discharge to powder-coated and bare metal housing parts	± 4 kV, 10 discharges, Criteria B:	± 4 kV, 10 discharges, Criteria B:	± 4 kV, 10 discharges, Criteria B:
Discharge through the air to plastic housing parts	± 8 kV, 10 discharges, Criteria B:	± 8 kV, 10 discharges, Criteria B:	± 8 kV, 10 discharges, Criteria B:

Table 38: Test requirement electrostatic discharge (ESD)

4.2 High-frequency Electromagnetic Fields (HF field)

Test carried out according to EN 61000-4-3	Limit values according to EN 61000-6-2	Limit values according to EN 61131-2	Limit values according to EN 55024
Housing, completely wired	80 MHz - 1 GHz, 10 V/m, 80 % amplitude modulation with 1 kHz, length 3 seconds, criteria A	80 MHz - 1 GHz, 1.4 - 2 GHz, 10 V/m, 80 % amplitude modulation with 1 kHz, length 3 seconds, criteria A 800-960 MHz (GSM), 10 V/m, pulse modulation with 50 % duty cycle, criteria A	80 MHz - 1 GHz, 1.4 - 2 GHz, 3 V/m, 80 % amplitude modulation with 1 kHz, length 3 seconds, criteria A

Table 39: Test requirement high-frequency electromagnetic fields (HF field)

4.3 High-speed Transient Electrical Disturbances (Burst)

Test carried out according to EN 61000-4-4	Limit values according to EN 61000-6-2	Limit values according to EN 61131-2	Limit values according to EN 55024
AC power I/O	± 2 kV, criteria B	-	± 1 kV, criteria B
AC power inputs	-	± 2 kV, criteria B	-
AC power outputs	-	± 1 kV, criteria B	-
DC power I/O >10 m ¹⁾	± 2 kV, criteria B	-	± 0.5 kV, criteria B
DC power inputs >10 m	-	± 2 kV, criteria B	-
DC power outputs >10 m	-	± 1 kV, criteria B	-
Functional ground connections, signal lines and I/Os >3 m	± 1 kV, criteria B	± 1 kV, criteria B	± 0.5 kV, criteria B
Unshielded AC I/O >3 m	-	± 2 kV, criteria B	-
Analog I/O	± 1 kV, criteria B	± 1 kV, criteria B	-

Table 40: Test requirement high-speed transient electrical disturbances (Burst)

1) For EN 55024 without length limitation.

4.4 Surge Voltages (Surge)

Test carried out according to EN 61000-4-5	Limit values according to EN 61000-6-2	Limit values according to EN 61131-2	Limit values according to EN 55024
AC power I/O, L to L	± 1 kV, criteria B	± 1 kV, criteria B	± 1 kV, criteria B
AC power I/O, L to PE	± 2 kV, criteria B	± 2 kV, criteria B	± 2 kV, criteria B
DC power I/O, L+ to L-, >10 m	± 0.5 kV, criteria B	-	-
DC power I/O, L to PE, >10 m	± 0.5 kV, criteria B	-	± 0.5 kV, criteria B
DC power inputs, L+ to L-	-	± 0.5 kV, criteria B	-
DC power inputs, L to PE	-	± 1 kV, criteria B	-
DC power outputs, L+ to L-	-	± 0.5 kV, criteria B	-
DC power outputs, L to PE	-	± 0.5 kV, criteria B	-
Signal connections >30 m	± 1 kV, criteria B	± 1 kV, criteria B	± 1 kV, criteria B
All shielded cables	-	± 1 kV, criteria B	-

Table 41: Test requirement surge voltages (Surge)

4.5 Conducted Disturbances

Test carried out according to EN 61000-4-6	Limit values according to EN 61000-6-2	Limit values according to EN 61131-2	Limit values according to EN 55024
AC power I/O	150 kHz - 80 MHz, 10 V, 80 % amplitude modulation with 1 kHz, length 3 seconds, criteria A	150 kHz - 80 MHz, 3 V, 80 % amplitude modulation with 1 kHz, length 3 seconds, criteria A	150 kHz - 80 MHz, 3 V, 80 % amplitude modulation with 1 kHz, Criteria A

Table 42: Test requirement conducted disturbances

Standards and Certifications • Requirements for Immunity to Disturbances

Test carried out according to EN 61000-4-6	Limit values according to EN 61000-6-2	Limit values according to EN 61131-2	Limit values according to EN 55024
DC power I/O	150 kHz - 80 MHz, 10 V, 80 % amplitude modulation with 1 kHz, length 3 seconds, criteria A	150 kHz - 80 MHz, 3 V, 80 % amplitude modulation with 1 kHz, length 3 seconds, criteria A	150 kHz - 80 MHz, 3 V, 80 % amplitude modulation with 1 kHz, Criteria A
Functional ground connections	0,15 - 80 MHz, 10 V, 80 % amplitude modulation with 1 kHz, Length 3 seconds, criteria A	150 kHz - 80 MHz, 3 V, 80 % amplitude modulation with 1 kHz, length 3 seconds, criteria A	-
Signal connections >3 m	0,15 - 80 MHz, 10 V, 80 % amplitude modulation with 1 kHz, Length 3 seconds, criteria A	150 kHz - 80 MHz, 3 V, 80 % amplitude modulation with 1 kHz, length 3 seconds, criteria A	150 kHz - 80 MHz, 3 V, 80 % amplitude modulation with 1 kHz, Criteria A

Table 42: Test requirement conducted disturbances (cont.)

4.6 Magnetic fields with energy technical frequencies

Test carried out according to EN 61000-4-8	Limit values according to EN 61000-6-2	Limit values according to EN 61131-2	Limit values according to EN 55024
Test direction x, test in the field of an induction coil 1 m x 1 m	30 A/m, criteria A	30 A/m, criteria A	50 Hz, 1 A/m, criteria A
Test direction y, test in the field of an induction coil 1 m x 1 m	30 A/m, criteria A	30 A/m, criteria A	50 Hz, 1 A/m, criteria A
Test direction z, test in the field of an induction coil 1 m x 1 m	30 A/m, criteria A	30 A/m, criteria A	50 Hz, 1 A/m, criteria A

Table 43: Test requirement magnetic fields with energy technical frequencies

4.7 Voltage dips, fluctuations and short-term interruptions

Test carried out according to EN 61000-4-11	Limit values according to EN 61000-6-2	Limit values according to EN 61131-2	Limit values according to EN 55024
AC power inputs	Voltage drop 70 % (30 % reduction), 0.5 periods, criteria B	-	Voltage drop < 5 % (> 95 % reduction), 0.5 half-oscillations, criteria B
AC power inputs	Voltage drop 40 % (60 % reduction), 5 periods, criteria C	-	Voltage drop 70 % (30 % reduction), 25 half-oscillations, criteria C
AC power inputs	Voltage drop 40 % (60 % reduction), 50 periods, criteria C	-	-
AC power inputs	Voltage Interruptions < 5 % (> 95 % reduction), 250 periods, criteria C	-	Voltage Interruptions < 5 % (> 95 % reduction), 250 half-oscillations, criteria C
AC power inputs	-	20 interruptions, 0.5 periods, criteria A	-
DC power inputs	-	20 interruptions for 10 ms, < UN - 15 %, criteria A	-

Table 44: Test requirement voltage dips, fluctuations and short-term interruptions

4.8 Damped Oscillations

Test carried out according to EN 61000-4-12	Limit values according to EN 61131-2		
Power I/O, L to L	± 1 kV, 1 MHz, repeat rate 400/seconds, length 2 seconds, connection lengths 2 m, criteria B		
Power I/O, L to PE	± 2.5 kV, 1 MHz, repeat rate 400/seconds, length 2 seconds, connection lengths 2 m, criteria B		

Table 45: Test requirement damped oscillations

5. Mechanical Conditions

Vibration	Test carried out according to	Limit values according to
Vibration operation	EN 60068-2-6	EN 61131-2: Programmable logic controllers
Vibration Transport	EN 60068-2-6	EN 60721-3-2 class 2M1
		EN 60721-3-2 class 2M2
		EN 60721-3-2 class 2M3
Shock Operation	EN 60068-2-27	EN 61131-2: Programmable logic controllers
		EN 60721-3-3 class 3M4
Shock Transport (packed)	EN 60068-2-27	EN 60721-3-2 class 2M1
		EN 60721-3-2 class 2M2
Toppling	EN 60068-2-31	EN 60721-3-2 class 2M1
		EN 60721-3-2 class 2M2
		EN 60721-3-2 class 2M3
Free fall (packed)	EN 60068-2-32	EN 61131-2: Programmable logic controllers

Table 46: Overview of limits and testing guidelines for vibration

5.1 Vibration Operation

Test carried out according to EN 60068-2-6	Limit values according to EN 61131-2			
Vibration operation: Uninterrupted duty with moveable frequency in all 3 axes (x, y, z), 1 octave per minute	10 sweeps for each axis			
	Frequency	Limit value		
	5 - 9 Hz	Amplitude 3.5 mm		
	9 - 150 Hz	Acceleration 1 g		

Table 47: Test requirement vibration operation

5.2 Vibration Transport

Test carried out according to EN 60068-2-6	Limit values according to EN 60721-3-2 class 2M1		Limit values according to EN 60721-3-2 class 2M2		Limit values according to EN 60721-3-2 class 2M3	
Vibration Transport: Uninterrupted duty with moveable frequency in all 3 axes (x, y, z)	10 sweeps for each axis, packed		10 sweeps for each axis, packed		10 sweeps for each axis, packed	
	Frequency	Limit value	Frequency	Limit value	Frequency	Limit value
	2 - 9 Hz	Amplitude 3.5 mm	2 - 9 Hz	Amplitude 3.5 mm	2 - 8 Hz	Amplitude 7,5 mm
	9 - 200 Hz	Acceleration 1 g	9 - 200 Hz	Acceleration 1 g	8 - 200 Hz	Acceleration 2 g
	200 - 500 Hz	Acceleration 1.5 g	200 - 500 Hz	Acceleration 1.5 g	200 - 500 Hz	Acceleration 4 g

Table 48: Test requirement vibration transport

5.3 Shock Operation

Test carried out according to EN 60068-2-27	Limit values according to EN 61131-2	Limit values according to EN 60721-3-3 class 3M4	
Shock Operation: Pulse shaped (half-sine) stress in all 3 axes (x, y, z)	Acceleration 15 g, Length 11 ms, 18 shocks	Acceleration 15 g, Length 11 ms	

Table 49: Test requirement shock operation

5.4 Shock Transport (packed)

Test carried out according to EN 60068-2-27	Limit values according to EN 60721-3-2 class 2M1	Limit values according to EN 60721-3-2 class 2M2	
Pulse shaped (half-sine) stress in all 3 axes (x, y, z)	Acceleration 10 g, Length 11 ms, each 3 shocks, Packed	Acceleration 30 g, Length 6 ms, each 3 shocks, Packed	

Table 50: Test requirement shock transport

5.5 Toppling

Test carried out according to EN 60068-2-31	Limit values according to EN 60721-3-2 class 2M1		Limit values according to EN 60721-3-2 class 2M2		Limit values according to EN 60721-3-2 class 2M3	
Toppling and knocking over	Devices: Toppling/knocking over on each edge		Devices: Toppling/knocking over on each edge		Devices: Toppling/knocking over on each edge	
	Weight	Required	Weight	Required	Weight	Required
	<20 kg	Yes	<20 kg	Yes	<20 kg	Yes
	20 - 100 kg	-	20 - 100 kg	Yes	20 - 100 kg	Yes
>100 kg	-	>100 kg	-	>100 kg	Yes	

Table 51: Test requirement toppling

5.6 Free Fall (packed)

Test carried out according to EN 60068-2-32	Limit values according to EN 61131-2		Limit values according to EN 60721-3-2 class 2M1		Limit values according to EN 60721-3-2 class 2M2		Limit values according to EN 60721-3-2 class 2M3	
	Weight	Height	Weight	Height	Weight	Height	Weight	Height
Free Fall	Devices with delivery packaging each with 5 fall tests		Devices packed		Devices packed		Devices packed	
	<10 kg	1.0 m	<20 kg	0.25 m	<20 kg	1.2 m	<20 kg	1.5 m
	10 - 40 kg	0.5 m	20 - 100 kg	0.25 m	20 - 100 kg	1.0 m	20 - 100 kg	1.2 m
	>40 kg	0.25 m	>100 kg	0.1 m	>100 kg	0.25 m	>100 kg	0.5 m
	Devices with product packaging each with 5 fall tests							
	Weight	Height						
	<10 kg	0.3 m						
	10 - 40 kg	0.3 m						
	>40 kg	0.25 m						

Table 52: Test requirement toppling

6. Climate Conditions

Temperature and Humidity	Test carried out according to	Limit values according to
Worst Case operation	UL 508	UL 508: Industrial control equipment EN 61131-2: Programmable logic controllers
Dry heat	EN 60068-2-2	EN 61131-2: Programmable logic controllers
Dry cold	EN 60068-2-1	EN 61131-2: Programmable logic controllers
Large temperature fluctuations	EN 60068-2-14	EN 61131-2: Programmable logic controllers
Temperature fluctuations in operation	EN 60068-2-14	EN 61131-2: Programmable logic controllers
Humid heat, cyclical	EN 60068-2-30	EN 61131-2: Programmable logic controllers
Humid heat, constant (storage)	EN 60068-2-3	EN 61131-2: Programmable logic controllers

Table 53: Overview limit value and test guideline standards temperature and humidity

6.1 Worst Case Operation

Test performed according to UL 508	Limit values according to UL 508	Limit values according to EN 61131-2	
Worst Case operation. Operation of the device with, in accordance with the data sheet, the maximum specified environmental temperature at the maximum specified load	Max. environmental temperature (min. +40 °C) for 3 hours, length 5 hours	Max. environmental temperature (min. +40 °C) for 3 hours, length 5 hours	

Table 54: Test requirement worst case operation

6.2 Dry Heat

Test carried out according to EN 60068-2-2	Limit values according to EN 61131-2		
Dry heat	1 cycle +70° C for 16 hours, then 1 hour acclimatization and testing functions, length 17 hours		

Table 55: Test requirement dry heat

6.3 Dry Cold

Test carried out according to EN 60068-2-1	Limit values according to EN 61131-2		
Dry cold	1 cycle -40° C for 16 hours, then 1 hour acclimatization and testing functions, length 17 hours		

Table 56: Test requirement dry cold

6.4 Large Temperature Fluctuations

Test carried out according to EN 60068-2-14	Limit values according to EN 61131-2		
Large temperature fluctuations	2 cycles - 25° C / + 70° C for each hour, then 2 hours acclimatization and testing of functions, length 14 hours		

Table 57: Test requirement large temperature fluctuations

6.5 Temperature Fluctuations in Operation

Test carried out according to EN 60068-2-14	Limit values according to EN 61131-2		
Open devices: These can also have a housing and are installed in the switching cabinet	5 cycles +5°C / +55°C for every 3 hours, temperature gradient 3°C / min, during the test, the device is occasionally supplied with voltage, length 30 hours		
Closed devices: They are devices which in accordance with the data sheet have a enveloping enclosure with the corresponding safety precautions.	5 cycles +5°C / +40 °C for every 3 hours, temperature gradient 3°C / min, during the test, the device is occasionally supplied with voltage, length 30 hours		

Table 58: Test requirement temperature fluctuations in operation

6.6 Humid Heat, Cyclical

Test carried out according to EN 60068-2-30	Limit values according to EN 61131-2		
Alternating air-conditioning	2 cycles +25°C / +55°C and 97 % / 83 % RH for every 24 hours, then 2 hours acclimatization as well as performing function and isolation tests, length 50 hours		

Table 59: Test requirement humid heat, cyclical

6.7 Humid Heat, Constant (storage)

Test carried out according to EN 60068-2-3	Limit values according to EN 61131-2		
Humid heat, constant (storage)	+40°C and 92.5 % RH for 48 h, then within 3 hours isolation test, length 49 hours		

Table 60: Test requirement humid heat, constant (storage)

7. Further Limit Values

Safety	Test carried out according to	Limit values according to
Ground resistance	EN 61131-2	EN 60204-1: Electrical equipment of machines
		EN 61131-2: Programmable logic controllers
Insulation resistance		EN 60204-1: Electrical equipment of machines
High voltage	EN 60060-1	EN 61131-2: Programmable logic controllers
		UL 508: Industrial control equipment

Table 61: Further Limit Values

Standards and Certifications • Further Limit Values

Safety	Test carried out according to	Limit values according to
Residual voltage	EN 61131-2	EN 60204-1: Electrical equipment of machines
		EN 61131-2: Programmable logic controllers
Leakage current		VDE 0701-1: Service, changes and testing of electrical devices
Overload	UL 508	EN 61131-2: Programmable logic controllers
		UL 508: Industrial control equipment
Simulation component defect	UL 508	EN 61131-2: Programmable logic controllers
		UL 508: Industrial control equipment
Voltage range		EN 61131-2: Programmable logic controllers

Table 61: Further Limit Values (cont.)

8. International Certifications

B&R products and services comply with the applicable standards. They are international standards from organizations such as ISO, IEC and CENELEC, as well as national standards from organizations such as UL, CSA, FCC, VDE, ÖVE, etc. We give special consideration to the reliability of our products in an industrial environment.



Certifications	
USA and Canada 	All important B&R products are tested and listed by Underwriters Laboratories and are checked quarterly by a UL inspector. This mark is valid for the USA and Canada and eases certification of your machines and systems in these areas.
Europe 	All harmonized EN standards for the valid guidelines are met.

Table 62: International Certifications

8.1 BGFE Certificate

In preparation!

9. Standards and Definitions for Safety Technology

Stop functions according to IEC 60204-1/11.98 (electrical equipment for machines, part 1: general requirements)

The following three stop function categories exist:

Category	Description
0	Stop by immediately switching off the power to the machine drive elements (i.e. uncontrolled stop).
1	A controlled stop, the power to the machine drive elements remains on until the stop procedure is completed. The power is switched off after the stop is complete.
2	A controlled stop, the power to the machine drive elements is not switched off.

Table 63: Overview of stop function categories

The necessary stop functions must be determined based on a risk evaluation for the machine. Stop functions in category 0 and category 1 must be able to function regardless of the operating mode. A category 0 stop must have priority. Stop functions must have priority over assigned start functions. Resetting the stop function is not allowed to cause a dangerous state.

Emergency stops according to IEC 60204-1/11.98 (electrical equipment for machines, part 1: general requirements)

The following requirements are valid for emergency stops in addition to the requirements for the stop functions:

- It must have priority over all other functions and operations in all operating modes.
- The power to the machine drive elements which can cause a dangerous state must be switched off as quickly as possible without creating other dangers.
- Resetting is not allowed to cause a restart.
- The E-stop function must not reduce the effectiveness of the safety equipment or of equipment with safety-related functions.
- The E-stop function must not interfere with equipment designed to free personnel from dangerous situations.

Emergency stops must be category 0 or category 1 stop functions. The necessary stop function must be determined based on a risk evaluation for the machine.

For emergency stop function in stop category 0, only hard wired, electromechanical equipment can be used. Additionally, the function is not allowed to depend on electronic switching logic (hardware or software) or the transfer of commands via a communication network or data connection.¹⁾

1) In accordance to the national foreword for the valid German version of IEC 60204-1/11.98, it is determined that electronic equipment (and especially emergency stop systems) can be used regardless of the stop category, if e.g. it provides the same safety using the standards EN 954-1 and/or IEC 61508 as required by IEC 60204-1.

When using a category 1 stop function for the emergency stop function, it must be guaranteed that the power to the machine drive elements is completely switched off. These elements must be switched off using electromechanical equipment¹⁾.

Safety category according to EN 954-1/03.97 (safety of machines - safety related parts of control systems, part 1: general design principles)¹⁾

The safety related parts of control systems must meet one or more of the requirements for five defined safety categories. The safety categories define the required behavior of safety related controller parts regarding their resistance to errors.

Safety Category (according to EN 954-1)	Safety integrity level - SIL (according to IEC 61508-2)	Short description	System Behavior
B	-	Safety related parts must be designed and built so that they can meet the expected operational requirements. (No specific safety measures are implemented.)	Caution! An error can cause the safety function to fail.
1	1	Safety related parts must be designed and built so that only reliable components and safety principles are used. (e.g. preventing short circuits by using sufficient distances, reducing the probability of errors by over-dimensioning components, defining the failure route - closed-circuit current principle, etc.)	Caution! An error can cause the safety function to fail.
2	1	Safety related parts must be designed so that their safety functions are checked in suitable intervals by the machine controller. (e.g. automatic or manual check during start-up)	Caution! An error between checks can cause the safety function to fail. If the safety function fails, it will be recognized during the check.
3	2	Safety related parts must be designed so that individual errors do not cause the safety function to fail. Individual errors should - if possible - be recognized the next time (or before) the safety function is required.	Caution! The safety function remains active when an error occurs. Some, but not all errors are recognized. A buildup of errors can cause the safety function to fail.
4	3	Safety related parts must be designed so that individual errors do not cause the safety function to fail. Individual errors must be recognized the next time (or before) the safety function is required. If this type of recognition is not possible, a buildup of errors is not allowed to cause the safety function to fail.	Information: The safety function remains active when an error occurs. Errors are recognized in time to prevent the safety function from failing.

Table 64: Safety category overview

These considerations lead to a safety category (B, 1, 2, 3, 4) that specifies how the safety-related parts on a machine must be implemented.

¹⁾ To prevent confusing EN 951-1 categories with IEC 60204-1 stop categories, the term "safety categories" was used in the text shown above for EN 954-1 categories.

Information:

Connections examples with a suitable monitoring device in chapter 3 "Start-up / Operation", section "Connection Examples for the E-stop and Key Switch", on page 86 and section "Connection Example for the Enable Switch", on page 90 show how safety category 4 according to EN 954-1 can be achieved with the Mobile Panel and its safety-related parts. Take note that the entire system concept must be designed accordingly.

Selecting the suitable safety category must be done based on a risk evaluation. This risk evaluation is a part of the total risk evaluation for the machine.

The following risk graph (according to EN 954-1, Appendix B) provides a simplified procedure for risk evaluation:

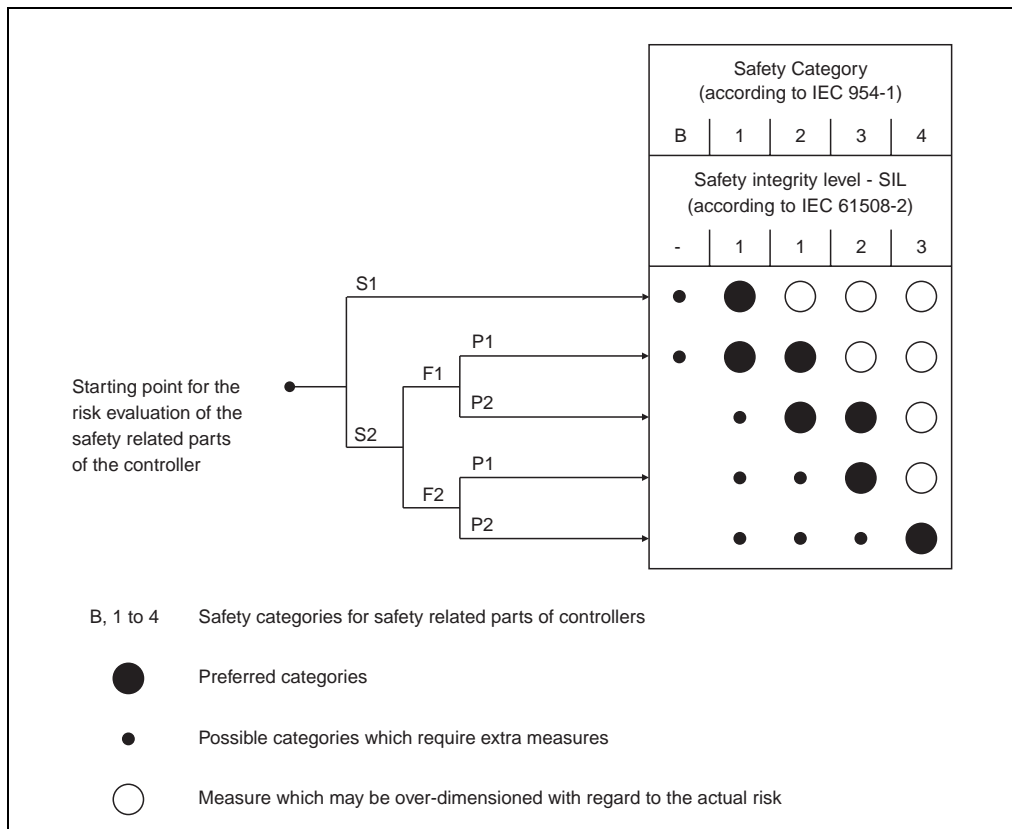

Figure 53: Risk graph according to EN 954-1, Appendix B

Begin at the starting point shown and follow the parameters S, F and P to the safety category to be used.

Parameter S ... Seriousness of injury	
S1	Light (usually reversible) injury.
S2	Serious (usually irreversible) injury.
Parameter F ... Frequency and/or duration of the danger exposure	
F1	Seldom to slightly more frequent and/or short exposure duration.
F2	Frequent to continuous and/or long exposure duration.
Parameter P ... Possibility to prevent danger	
P1	Possible under some conditions.
P2	Nearly impossible.

Table 65: Parameters S, F and P lead you to the safety category to be used

Restart inhibit according to EN 1037/04.96 (Safety of machinery - prevention of unexpected start-up)

Keeping a machine in an idle state when people are working in the danger zone is one of the most important requirements for safe operation of machines.

Starting refers to the transition of a machine or its parts from an idle state to moving state. Any start is unexpected if it is caused by:

- A start command sent because of a controller failure or because of external influences on the controller.
- A start command sent because of incorrect operation of a start element or another part of the machine.
- Restoration of power supply after an interruption.
- External/internal influences on parts of the machine.

To prevent unexpected starting of machines or parts of machines, power should be removed and dissipated. If this is not practical (e.g. frequent, short work in danger zone), other measures must be taken:

- Measures to prevent random start commands.
- Measures to prevent that random start commands cause unexpected starting.
- Measures to automatically stop dangerous parts of the machine before a dangerous situation can be caused by unexpected starting.

Chapter 6 • Accessories

1. Overview

Model Number	Description	Note
0AC201.9	Lithium Batteries (5x) Lithium batteries, 5 pcs., 3 V / 950 mAh, button cell	
4A0006.00-000	Lithium Battery (1x) Lithium battery, 1 piece, 3 V / 950 mAh, button cell	
5AC900.1100-00	Touch screen pen Five replacement touch screen pens	
5CFCRD.0032-02	Compact Flash 32 MB TrueIDE SanDisk/A Compact Flash card with 32 MB Flash PROM, and true IDE/ATA interface.	
5CFCRD.0064-02	Compact Flash 64 MB TrueIDE SanDisk/A Compact Flash card with 64 MB Flash PROM, and true IDE/ATA interface.	
5CFCRD.0128-02	Compact Flash 128 MB TrueIDE SanDisk/A Compact Flash card with 128 MB Flash PROM, and true IDE/ATA interface.	
5CFCRD.0256-02	Compact Flash 256 MB TrueIDE SanDisk/A Compact Flash card with 256 MB Flash PROM, and true IDE/ATA interface.	
5CFCRD.0512-02	Compact Flash 512 MB TrueIDE SanDisk/A Compact Flash card with 512 MB Flash PROM, and true IDE/ATA interface.	
5CFCRD.1024-02	Compact Flash 1024 MB TrueIDE SanDisk/A Compact Flash card with 1024 MB Flash PROM, and true IDE/ATA interface.	
5CFCRD.2048-02	Compact Flash 2048 MB TrueIDE SanDisk/A Compact Flash card with 2048 MB Flash PROM, and true IDE/ATA interface	
5MMUSB.0128-00	USB memory stick 128 MB SanDisk USB 2.0 Memory Stick 128 MB	
5MMUSB.0256-00	USB memory stick 256 MB SanDisk USB 2.0 Memory Stick 256 MB	
5MMUSB.0512-00	USB memory stick 512 MB SanDisk USB 2.0 Memory Stick 512 MB	

Table 66: Model numbers for accessories

2. Replacement CMOS Batteries

The lithium battery is needed for buffering the BIOS and real-time clock.

2.1 Order Data

Model Number	Description	Image
0AC201.9	Lithium batteries, 5 pcs., 3 V / 950 mAh button cell	
4A0006.00-000	Lithium battery, 1 piece, 3 V / 950 mAh, button cell	

Table 67: Order data for lithium batteries

2.2 Technical Data

Information:

The following defined characteristics, features and limit values are only valid for this accessory and can deviate from the entire device. For the entire device where, for example, this accessory is installed, the data given for the entire device is valid.

Name	0AC201.9, 4A0006.00-000
Capacity	950 mAh
Voltage	3 V
Self Discharge at 23°C	< 1% per year
Storage Time	Max. 3 years at 30° C
Storage Temperature	-20 °C to +60° C
Humidity	0 to 95 % (non-condensing)

Table 68: Technical data for lithium batteries

3. Touch Screen Pen

A replacement part is available consisting of 5 touch screen pens for the operation of the Mobile Panel touch screen. See section "Touch Screen Pen", on page 30 for technical data regarding touch screen pens.

3.1 Order Data

Model Number	Description	Image
5AC900.1100-00	Touch screen pen (5x)	

Table 69: Oeder data for the touch screen pen

4. Compact Flash cards 5CFCRD.xxxx-02

4.1 General Information

Compact Flash cards are easy-to-exchange memory media. Due to their robustness against environmental influences (e.g. temperature, shock, vibration, etc.), Compact Flash cards are ideal for use as memory media in industrial environments.

4.2 Order Data

Model Number	Description	Image
5CFCRD.0032-02	Compact Flash 32 MB TrueIDE SanDisk/A	
5CFCRD.0064-02	Compact Flash 64 MB TrueIDE SanDisk/A	
5CFCRD.0128-02	Compact Flash 128 MB TrueIDE SanDisk/A	
5CFCRD.0256-02	Compact Flash 256 MB TrueIDE SanDisk/A	
5CFCRD.0512-02	Compact Flash 512 MB TrueIDE SanDisk/A	
5CFCRD.1024-02	Compact Flash 1024 MB TrueIDE SanDisk/A	
5CFCRD.2048-02	Compact Flash 2048 MB TrueIDE SanDisk/A	

Table 70: Order data for Compact Flash cards

4.3 Technical Data

Information:

The following defined characteristics, features and limit values are only valid for this accessory and can deviate from the entire device. For the entire device where, for example, this accessory is installed, the data given for the entire device is valid.

Features	5CFCRD.xxxx-02
MTBF (@ 25°C)	> 3,000,000 hours
Maintenance	None
Data Reliability	< 1 unrecoverable error in 10 ¹⁴ bit read accesses < 1 faulty correction in 10 ²⁰ bit read accesses
Clear/Write Procedures	> 2,000,000 times
Mechanics	5CFCRD.xxxx-02

Table 71: Compact Flash cards 5CFCRD.xxxx-02 technical data

Dimensions	
Length	36.4 ± 0.15 mm
Width	42.8 ± 0.10 mm
Thickness	3.3 mm ± 0.10 mm
Weight	11.4 g
Environment	
Environmental Temperature	
Operation	0 °C to +70 °C
Storage	-25 °C to +85 °C
Transport	-25 °C to +85 °C
Humidity	
Operation/Storage	8% to 95%, non-condensing
Vibration	
Operation/Storage	Maximum 30 G (point to point)
Shock	
Operation/Storage	Maximum 3000 G
Altitude	24000 meters

Table 71: Compact Flash cards 5CFCRD.xxxx-02 technical data (cont.)

4.4 Dimensions

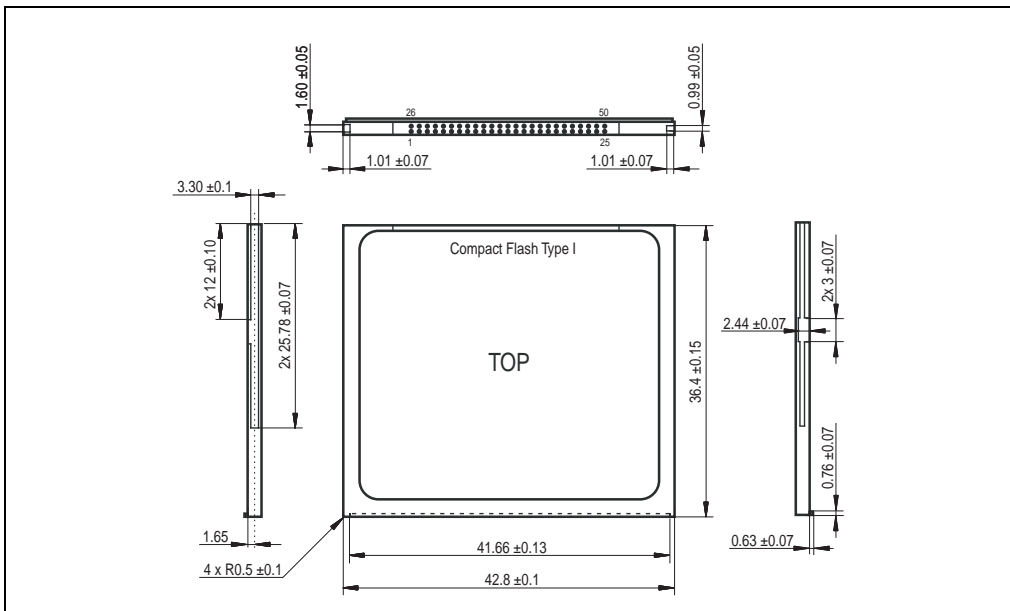

Figure 54: Dimensions for Compact Flash card type I

4.5 Calculating the Lifespan

SanDisk provides a 6-page "White Paper" for the lifespan calculation for Compact Flash cards (see following pages). This document can also be found on the SanDisk homepage.

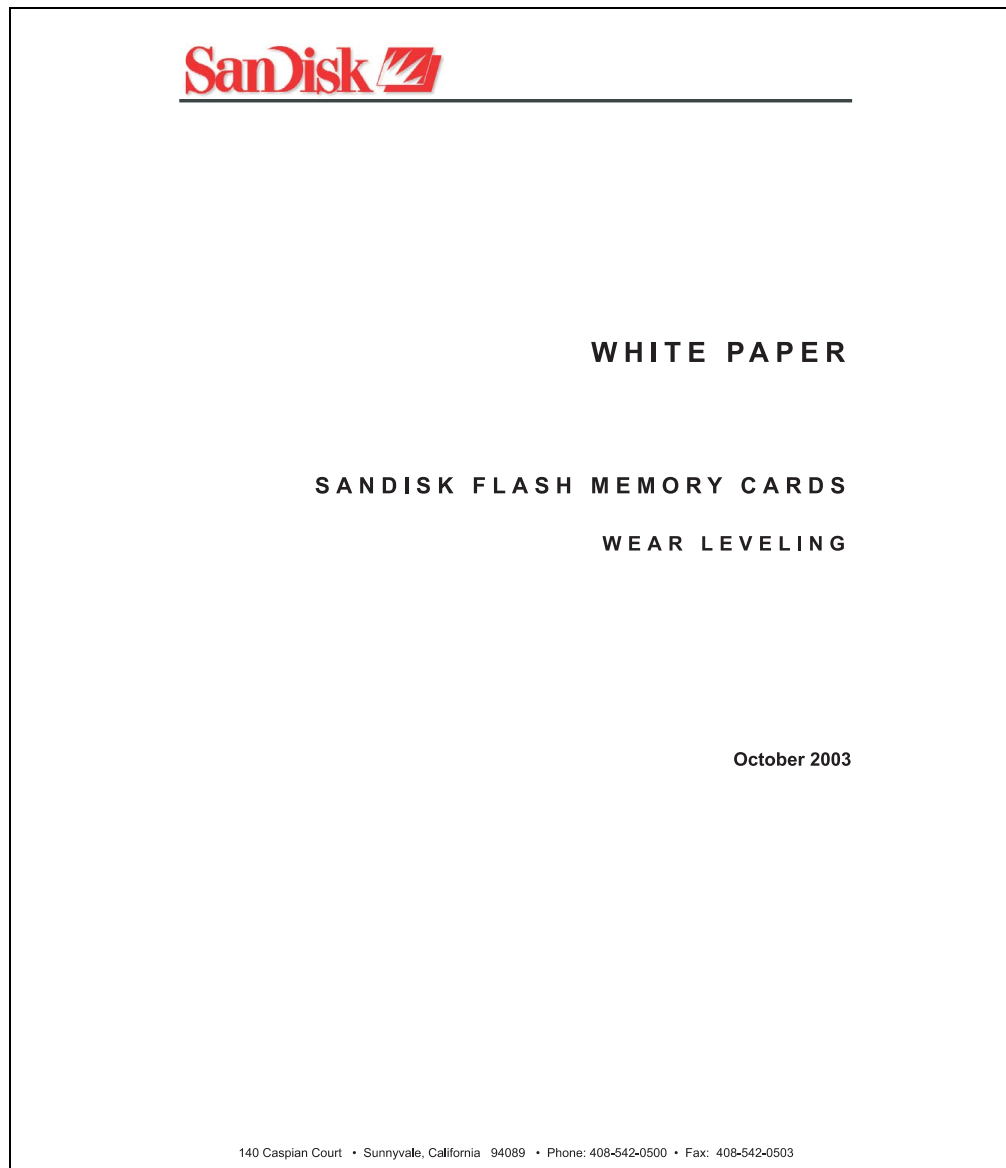

Figure 55: SanDisk White Paper - page 1

SanDisk® Corporation general policy does not recommend the use of its products in life support applications where in a failure or malfunction of the product may directly threaten life or injury. Per SanDisk Terms and Conditions of Sale, the user of SanDisk products in life support applications assumes all risk of such use and indemnifies SanDisk against all damages.

The information in this manual is subject to change without notice.

SanDisk Corporation shall not be liable for technical or editorial errors or omissions contained herein; nor for incidental or consequential damages resulting from the furnishing, performance, or use of this material.

All parts of the SanDisk documentation are protected by copyright law and all rights are reserved. This documentation may not, in whole or in part, be copied, photocopied, reproduced, translated, or reduced to any electronic medium or machine-readable form without prior consent, in writing, from SanDisk Corporation.

SanDisk and the SanDisk logo are registered trademarks of SanDisk Corporation.

Product names mentioned herein are for identification purposes only and may be trademarks and/or registered trademarks of their respective companies.

© 2003 SanDisk Corporation. All rights reserved.

SanDisk products are covered or licensed under one or more of the following U.S. Patent Nos. 5,070,032; 5,095,344; 5,168,465; 5,172,338; 5,198,380; 5,200,959; 5,268,318; 5,268,870; 5,272,669; 5,418,752; 5,602,987. Other U.S. and foreign patents awarded and pending.

Lit. No. 80-36-00278 10/03 Printed in U.S.A.

SanDisk Corporation

Doc No. 80-36-00278

SanDisk Flash Memory Cards Wear Leveling

Page 2

Figure 56: SanDisk White Paper - page 2

OVERVIEW

This purpose of this white paper is to help SanDisk customers understand the benefits of wear leveling and to assist customers in calculating life expectancy of SanDisk cards in specific applications.

Flash memory is susceptible to wear as a result of the repeated program and erase cycles that are inherent in typical data storage applications. Applications in which this is a major concern include hard disk replacement applications where write operations occur frequently. How a storage system manages the wear of the memory is key to understanding the extended reliability of the host that relies on these storage systems.

WEAR LEVELING METHODOLOGY

Current products available in the industrial channel use NAND flash memory. It is important to understand the NAND memory architecture to gain insight into the wear leveling mechanism.

Each memory chip is divided into blocks. A block is an array of memory cells organized as sectors. The number of blocks and sectors vary from product to product. The minimum unit for a write or read operation is a page (or sector). The minimum unit for an erase operation is a block. Physical blocks are logically grouped into zones. For the current technology, a typical zone size is 4 MB. However, this may change from product to product. Wear leveling is done within a zone. The current firmware does not spread the wear across the capacity of the card. Each zone has about 3% additional "spare blocks" beyond what is assigned to meet the logical capacity of the flash card. This group of blocks is commonly referred to as the "Erase Pool".

With the introduction of SanDisk's Write-before-Erase architecture, each time a host writes data to the same logical address (CHS or LBA), data is written into a newly assigned, empty physical block from the "Erase Pool". The intrinsic nature of writing to a new physical location each time a logical address is written to is the basis for wear leveling found in SanDisk cards. This action spreads the writes over the zone, thus greatly extending the overall life of the card. The methodology of using a large number of physical addresses to manage a smaller logical address table allows for rotation of the physical addresses among the entire group of physical blocks within a zone. The resulting wear leveling optimizes the effective life of the media and avoids prematurely reaching the end of life on frequently written to host addresses.

When a card detects that a block has reached the end of its useful life, it removes that block from the blocks that are available for write operations. The result is a reduction of the size of the erase pool. This does not affect the capacity of the card as seen by the host. When the pool of blocks available for write operations has been exhausted due to wear, the card will reach the end of its useful life for write operations.

SanDisk Corporation

Doc No. 80-36-00278

SanDisk Flash Memory Cards Wear Leveling

Page 3

Figure 57: SanDisk White Paper - page 3

Current SanDisk products do not preempt wear leveling events during normal operation of the card. Applications typically don't require such management beyond the natural wear leveling that occurs during normal host operations. As a result, the effectiveness of wear leveling in current SanDisk products is dependent upon host usage. It is important for customers whose applications do not fall into this typical usage pattern to understand how their applications will affect the lifetime of the card.

LIFE EXPECTANCY SCENARIOS

► best case analysis

In a typical application, large data files are written to the card occupying contiguous sequential logical address space. This results in optimal wear leveling and provides card life exceeding the specification for card endurance. This increased endurance is achieved as follows: The 2,000,000 endurance cycles specification (I-Grade only) is a result of large amounts of test data collected from a very large sample set that accounts for the extreme limits of the test population. With the 3% additional erase pool being used in an ideal fashion, the distribution is narrowed and the card will survive beyond its specified lifetime.

► worst case analysis

In the worst-case application, data will be written as single sectors to random addresses across the card. These single sector writes will exercise the erase pool more rapidly, requiring the system to perform a "garbage collection" operation to free up new blocks for subsequent write operations. At the extreme, each single sector write would cause one block to be programmed and erased. As a typical block size is 16kB or 32 sectors, the amount of wear is increased by a factor of 31 since 32 physical sectors are written and erased for each sector the host writes. Spreading this wear across the erase pool results in an effective 1/30 usable lifetime. This case is an extreme example and is only included to show the range of application dependence. This result is comparable to other vendor's cards based on memory with a 16kB erase block.

► analysis of host dependence

In assessing the life expectancy of a card in a given system several factors need to be understood. These factors include the types of files and their corresponding sizes, frequency of card write operations and file system behavior (including data structures). The types of files must be considered since some files, such as operating systems or executable files, typically remain in fixed locations once they are stored in the card. This limits the number of physical blocks available for circulation into the erase pool. The remaining capacity after these files have been accounted for can then be divided by the typical size of files that will be updated over the lifetime of the card. Related to this calculation is how the file system overwrites existing files. Typical operating system behavior, such as DOS, will allocate new blocks from the file allocation table, or FAT, and so repeated file writes will occupy a new set of addresses on the card. This is very beneficial in spreading wear across the card since it forces the card to cycle the entire physical

SanDisk Corporation

Figure 58: SanDisk White Paper - page 4

area being used for such files. Special cases to consider include those where the files being updated are very small. Typically an operating system uses a minimum number of sectors to store a file, referred to as a cluster. Typical cluster sizes range from 8 to 64 sectors in size. The cluster size is important for files that are the same or smaller than the 32-sector block since these may trigger garbage collection operations. If these updates happen in a random fashion (sequential updates would not be affected by cluster size) lifetime may be reduced as a result. Finally, the frequency of such updates is then used to determine how long it will take before the card reaches its statistical limit for endurance. These factors can be combined in an equation that can be used to calculate the minimum time a card will function in that application:

$$lifetime = 2,000,000 \times \frac{(C_{zone} - C_{fixed}) \times \left(1 - k_r \times \frac{32 - N_{cluster}}{32}\right)}{FS_{typ}} \times \frac{1}{f_w}$$

where Czone is the total capacity of the zone, Cfixed is the capacity used by fixed files, Ncluster is the cluster size, FStyp is the average file size and fw is the average frequency at which files are updated. kr is a factor that is 0 for file sizes that are typically over 16kB or for applications that are not random in the order in which such files are updated.

Example 1

In this example 128 KB of data is updated once a day. The zone has 500 KB worth of fixed files. A 4 MB zone size is assumed.

$$lifetime = 2,000,000 \times \frac{(4000 - 500) \times (1 - 0)}{128} \times \frac{1}{1/day}$$

$$lifetime = 149828 \text{ years}$$

Example 2

This example is a data logging operation using a 1GB card where a 4kB file is updated every five seconds. This would result in sequential address being written.

$$lifetime = 2,000,000 \times \frac{4000}{4} \times \frac{1}{1/5 \text{ sec}}$$

$$lifetime = 317 \text{ years}$$

SanDisk Corporation

Example 3

This example is a data logging operation using the same 1GB card where a new 4kB file is written every five seconds. But in this case the cluster size is 4kB and it is expected that, due to file system fragmentation, the logical addresses will be written randomly.

$$lifetime = 2,000,000 \times \frac{4 \times \left(1 - 1 \times \frac{32-8}{32}\right)}{.004} \times \frac{1}{1/5 \text{ sec}}$$

$$lifetime = 79.3 \text{ years}$$

CONCLUSION

These examples are general in nature but show how the equation can be used as a guideline for calculating card lifetime in different applications. They also demonstrate that SanDisk card architecture exceeds reasonable life expectancy in typical applications. If a particular applications behaves in such a way that this equation cannot be applied, the SanDisk Applications Engineering group can assist in performing card lifetime analysis.

For more information, please visit the SanDisk Web site at: www.sandisk.com

SanDisk Corporation

Corporate Headquarters
140 Caspian Court
Sunnyvale, CA 94089
408-542-0500
FAX: 408-542-0503
URL: <http://www.sandisk.com>

SanDisk Corporation

Figure 60: SanDisk White Paper - page 6

5. USB Memory Stick

5.1 General Information

USB memory sticks are easy-to-exchange memory media. Because of the fast data transfer USB 2.0, USB memory sticks provide optimal values for use as a portable memory medium. "Hot PLUG & PLAY" - without requiring additional drivers (except with Windows 98SE), the USB memory stick can be converted immediately into an additional drive, in which data can be read from or written to. Only USB memory sticks from the memory specialists [SanDisk](#) are being used.

5.2 Order Data

Model Number	Description	Image
5MMUSB.0128-00	USB memory stick 128 MB SanDisk	
5MMUSB.0256-00	USB memory stick 256 MB SanDisk	
5MMUSB.0512-00	USB memory stick 512 MB SanDisk	

Table 72: USB memory stick order data

5.3 Technical Data

Information:

The following defined characteristics, features and limit values are only valid for this accessory and can deviate from the entire device. For the entire device where, for example, this accessory is installed, the data given for the entire device is valid.

Features	5MMUSB.0xxx-00
LED	1 LED (green), signals data transfer (send and receive)
Power Supply Current Requirements	via the USB port < 650 µA in sleep mode, < 150 mA read/write
Interface Type Transfer Rate Sequential Reading Sequential Writing Connection	USB specification 2.0 high speed device, mass storage class, USB-IF and WHQL certified USB 1.1 and 2.0 compatible up to 480 MBit (high speed) Max. 8.7 MB/second Max. 1.7 MB/second to each USB type A interface

Table 73: USB memory stick 5MMUSB.0xxx-00 technical data

Features	5MMUSB.0xxx-00
MTBF (@ 25°C)	> 100000 hours
Data Preservation	10 years
Maintenance	None
Operating System Support	Windows CE 4.1, CE 4.2, 98SE ¹⁾ , ME, 2000, XP Mac OS 9.1 and 10.1.2+
Mechanics	
Dimensions	
Length	62 mm
Width	19 mm
Thickness	11 mm
Environment	
Environmental Temperature	
Operation	0 °C to +45 °C
Storage	-20 °C to +60° C
Transport	-20 °C to +60° C
Humidity	
Operation	10 % to 90 %, non-condensing
Storage	5 % to 90 %, non-condensing
Transport	5 % to 90 %, non-condensing
Vibration	
Operation	2 G (10 to 500 Hz), oscillation rate 1/minute
Storage	4 G (10 to 500 Hz), oscillation rate 1/minute
Transport	4 G (10 to 500 Hz), oscillation rate 1/minute
Shock	
Operation	40 G and 11 ms duration (all axes)
Storage	80 G and 11 ms duration (all axes)
Transport	80 G and 11 ms duration (all axes)
Altitude	
Operation	3048 meters
Storage	12192 meters
Transport	12192 meters

Table 73: USB memory stick 5MMUSB.0xxx-00 technical data (cont.)

1) For Win 98SE, a driver can be downloaded from the [SanDisk](#) homepage.

Chapter 7 • Maintenance / Servicing

1. Cleaning

Danger!

Mobile Panel devices may only be cleaned when switched off. This is to prevent unintended functions from being triggered when touching the touch screen or pressing the buttons or entry devices.

A moist towel should be used to clean the Mobile Panel device. When moistening the cloth, use only water with detergent, screen cleaning agent, or alcohol (ethanol). The cleaning agent should be applied to the cloth beforehand, not sprayed directly on the Mobile Panel device! Never use aggressive solvents, chemicals, or scouring agents.

Information:

Displays with touch screens should be cleaned at regular intervals.

2. Exchanging the Connection Cable

Danger!

The attachment cable may only be exchanged by trained personnel when the Mobile Panel device and the entire system are turned off.

2.1 Procedure

Warning!

Before dismounting, place the Mobile Panel device on a clean flat surface with the display facing down so that the operating elements are not damaged.

- 1) Remove the handle by loosening the hex screw with a 4 mm screwdriver.

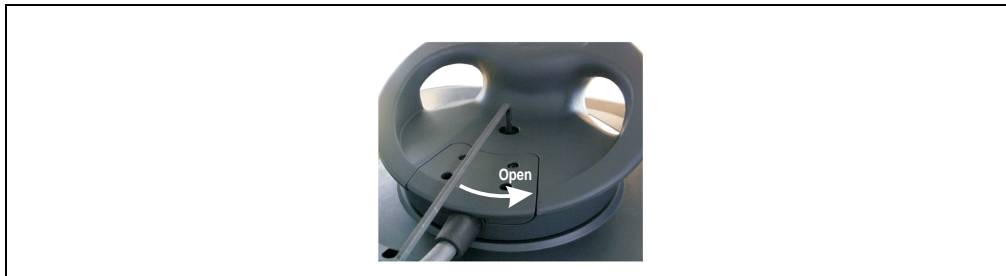

Figure 61: Taking out the locking screw

- 2) Tip up the side of handle to release the connectors of the old attachment cable to the panel.

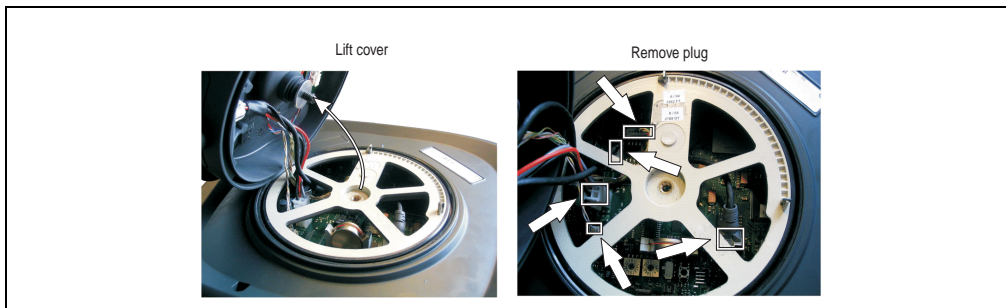

Figure 62: Removing the attachment cable

- 3) Remove the enable switch connector.

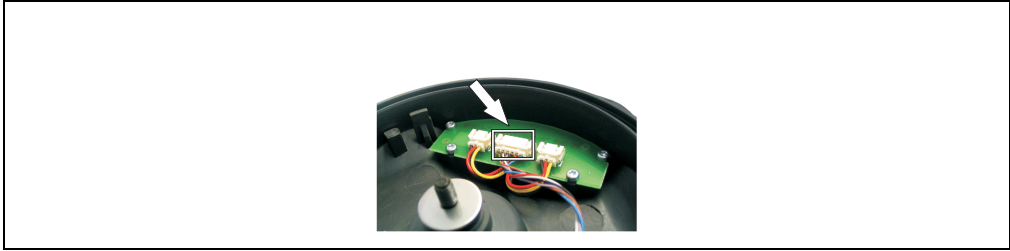

Figure 63: Removing the enable switch connector

- 4) Separate the attachment from the handle. To do so, the four cover screws need to be removed (using a Torx size 10 screwdriver) and the old attachment cable pulled through the cable opening.



Figure 64: Handle clasp screw positions

- 5) Lead the new attachment cable carefully through the cable opening, connector to connector (1). Place the cable tie for stress relief (2). Put on the cover and re-screws the screws tightly (3).

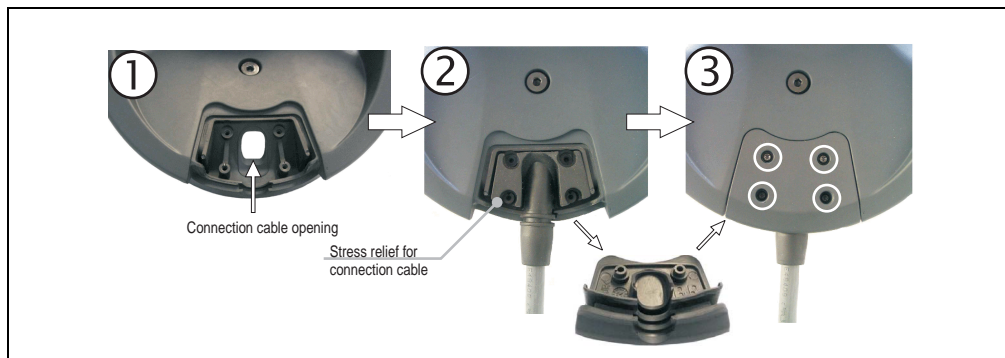

Figure 65: Connecting the attachment cable and handle

- 6) Connect the enable switch connector (ST1) to the handle.

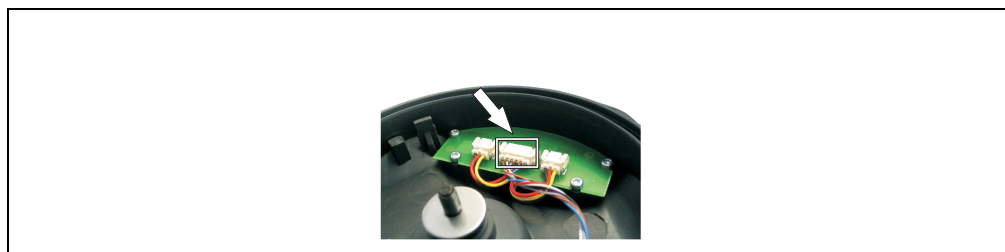

Figure 66: Connecting the enable switch connector (ST1)

- 7) Connect the Mobile Panel attachment cable to the panel (ST2, ST3, ST4, ST5, ST6). See figure 31 "Connection cable 5CAMPH.0xxx-00" on page 64 for connecting the cable. Cables may only be guided through the housing opening identified in figure 67 "Connectors and cable arrangement" (see arrow).

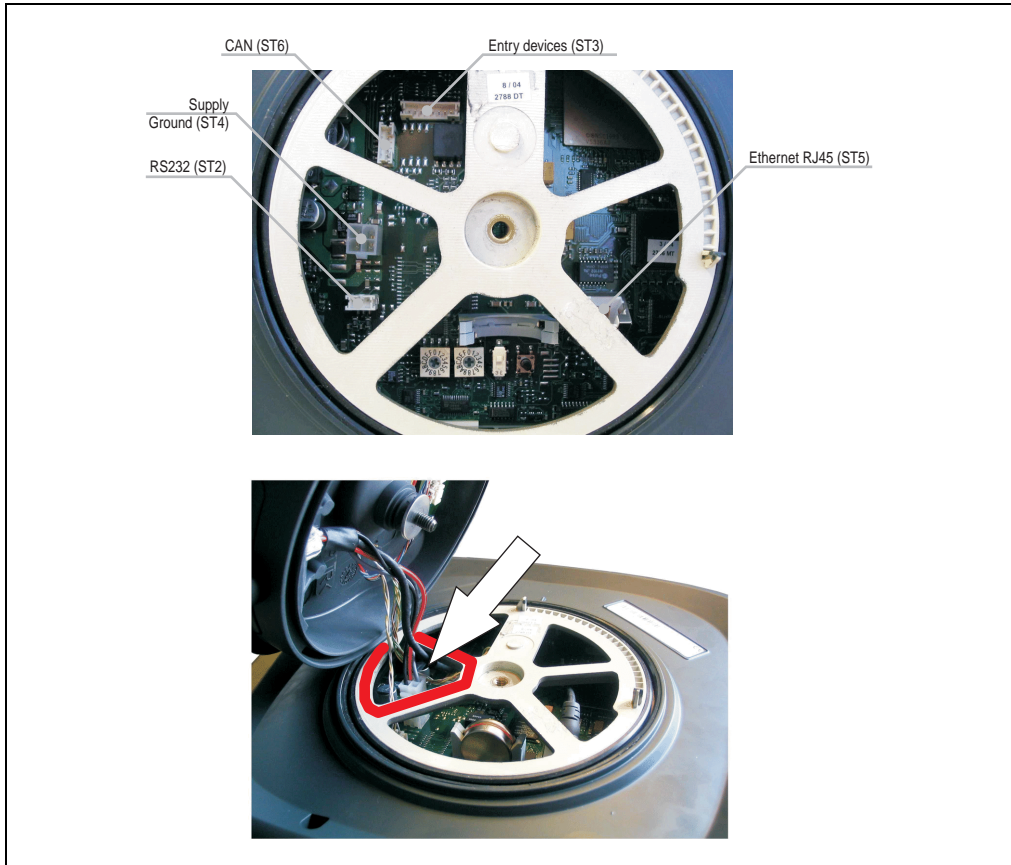

Figure 67: Connectors and cable arrangement

Information:

When connecting the Ethernet RJ45 connector (ST5) and the power supply connector (ST4), make sure that the connector locking mechanisms are engaged.

- 8) Put the handle and panel back together again. Note the following when doing so: All cables must be guided through to the left of the cover screws (1) (2). When placing the handle, both the of the existing markings (3) must be on top of each other.

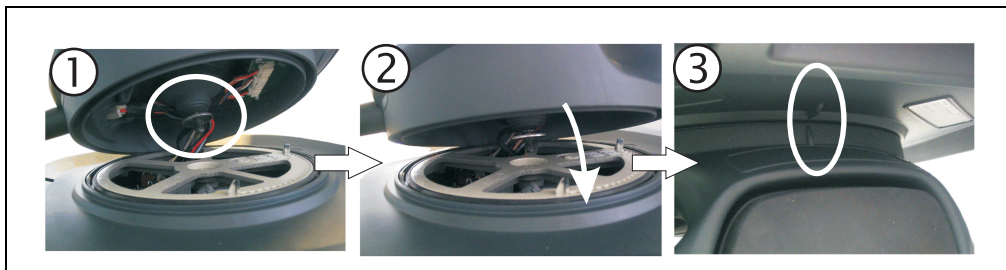

Figure 68: Connecting the handle with the panel

Danger!

Before putting the handle and the panel back together again, all connectors -- especially those for the safety engineering (enable switch connector (ST1) and the entry device (ST3)) -- must be checked for contact with the attachment cable!

Warning!

Cables may not be wedged in when the unit is put back together.

- 9) Screw in the cover screw.

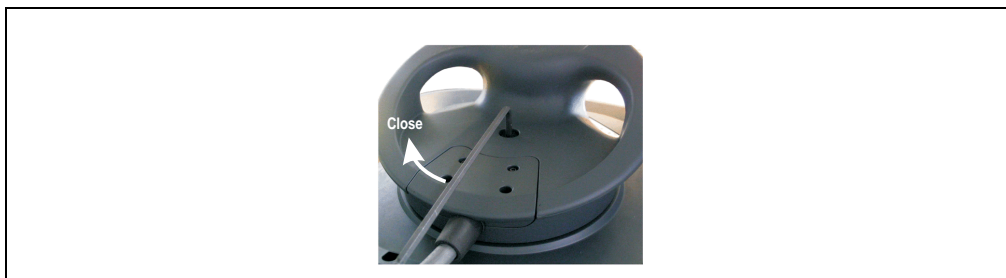

Figure 69: Tightening the cover screw

Danger!

Before commissioning the machine or system, all safety features of the Mobile Panel device must be checked for functionality.

3. Changing the Battery

Batteries only need to be changed on devices which have a lithium battery.

The lithium battery guarantees buffering of the internal real-time clock (RTC), SRAM data, and individually saved BIOS settings. The battery status (good or bad) can be queried using software. From the point when battery capacity is recognized as insufficient, data buffering is guaranteed for approximately another 500 hours. When changing the battery, data is buffered for approximately another 10 minutes by a gold leaf capacitor. The buffer duration of the battery lasts at least two years (at 50°C).

Danger!

The battery may only be exchanged by trained personnel when the Mobile Panel device and the entire system are turned off.

3.1 Procedure

Warning!

Before dismounting, place the Mobile Panel device on a clean flat surface with the display facing down so that the operating elements are not damaged.

- 1) Remove the handle by loosening the hex screw with a 4 mm screwdriver.

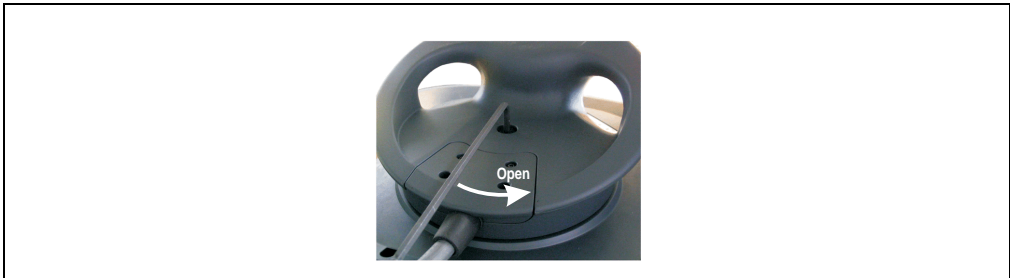

Figure 70: Taking out the locking screw

Maintenance / Servicing • Changing the Battery

- 2) Tip up the side of the handle and remove the battery from the fixture (don't use pliers or uninsulated tools --> risk of short circuit). The battery should not be held by its edges. Insulated tweezers may also be used for removing the battery.

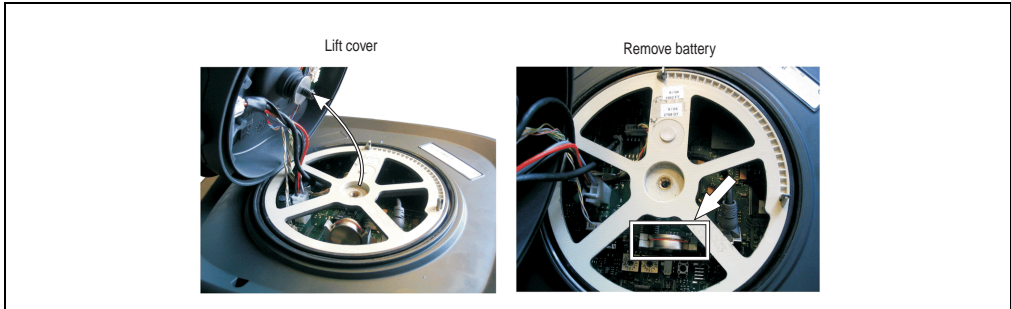

Figure 71: Removing the attachment cable

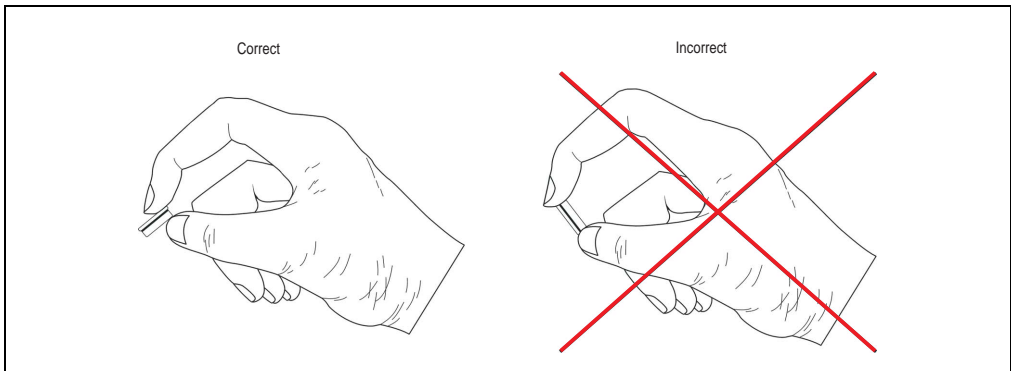

Figure 72: Handling the battery

- 3) After removing the battery, the data is buffered for at least another 10 minutes by a gold leaf capacitor so that data is not lost. Insert the new battery with correct polarity.

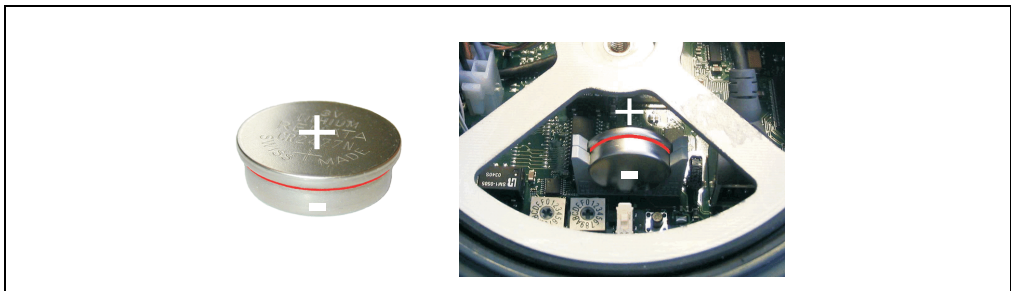

Figure 73: Inserted lithium battery

- 4) Put the handle and panel back together again. Note the following when doing so: All cables must be guided through to the left of the cover screws (1) (2). When placing the handle, both the of the existing markings (3) must be on top of each other.

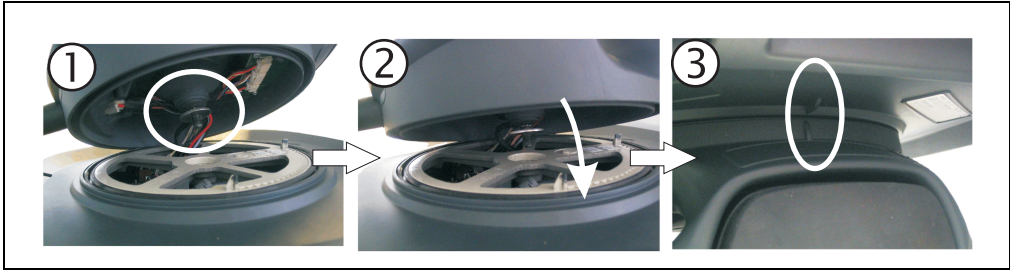

Figure 74: Connecting the handle with the panel

Danger!

Before putting the handle and the panel back together again, all connectors -- especially those for the safety engineering (enable switch connector (ST1) and the entry device (ST3)) -- must be checked for contact with the attachment cable!

Warning!

Cables may not be wedged in when the unit is put back together.

- 5) Screw in the cover screw.

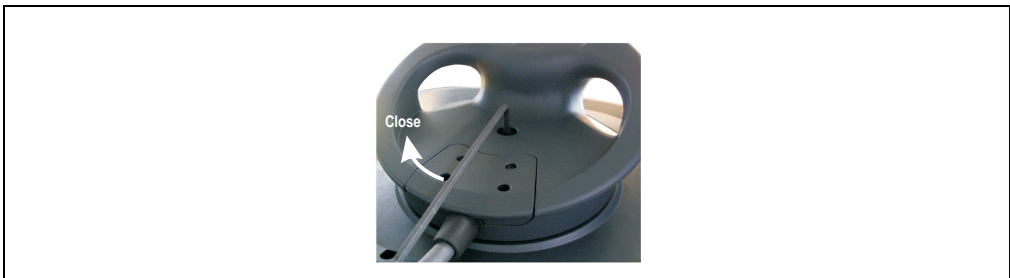

Figure 75: Tightening the cover screw

Danger!

Before commissioning the machine or system, all safety features of the Mobile Panel device must be checked for functionality.

Appendix A

The following characteristics, features and limits values only refer to the push button and are not valid for the Mobile Panel device as a whole. For the individual operator panels, the entries listed in chapter 2 "Technical Data", section 2 "Entire Device" on page 24 and in the respective technical data section are valid (see section "Technical Data", on page 39).

1. E-stop button

The E-stop unit consists of an E-stop switching element and an E-stop button.

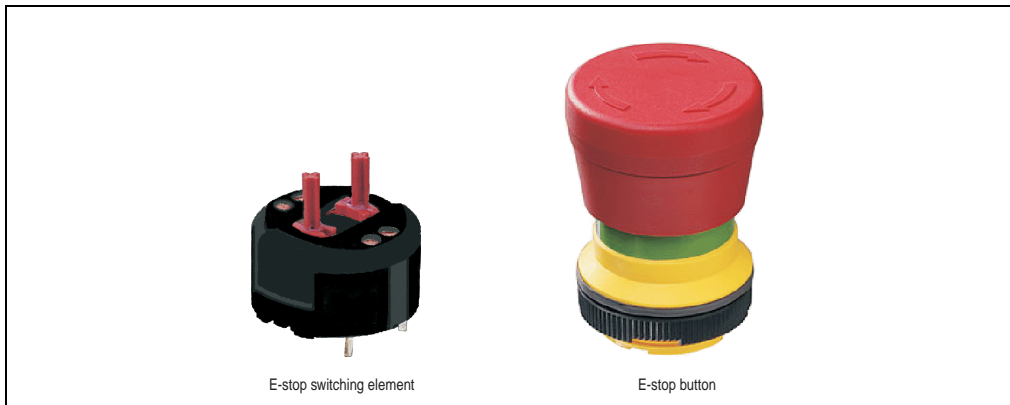

Figure 76: E-stop unit

Information:

The following characteristics, features and limit values are only valid for these individual components and can deviate from those for the entire device. For the entire device where, for example, these individual components are used, the data given for the entire device is valid.

Property	E-stop Switching element	E-stop button
Manufacturer Type	RAFI 22FS switching element E-stop, 2 Ö	RAFI 22FS E-stop, not illuminated
Operating Voltage AC/DC	Max. 120 V	-

Table 74: Technical data for E-stop switching element and E-stop button

Key Switch

Property	E-stop Switching element	E-stop button
Operating Current AC/DC	Max. 550 mA	-
Contact System	Self-cleaning bridge contact	-
Standards	Positive opening contact according to IEC 947-5-1	-
Normally Closed Contact	-	According to IEC 68-1-2, 2-2 and 2-30
Weathering Resistance	-	According to IEC 68-2-11
Salt Mist	-	IP65
Protection (front side)	-	IEC 947, 1058; UL 508; CSA 22.2;
Approbations	-	EU-NSR 73/23; Ulc
Impact Resistance	At least 100 N	
Operating Force	Approx. 5 N per contact element	-
Lifespan	1 million actuations at 10 mA/24 VDC	50000 actuations
Environmental Temperature		
Operation	-25 °C to +70 °C	
Storage	-40 °C to +80 °C	
Transport	-40 °C to +80 °C	

Table 74: Technical data for E-stop switching element and E-stop button (cont.)

2. Key Switch

The key switch unit consists of a key switch switching element and a key switch.

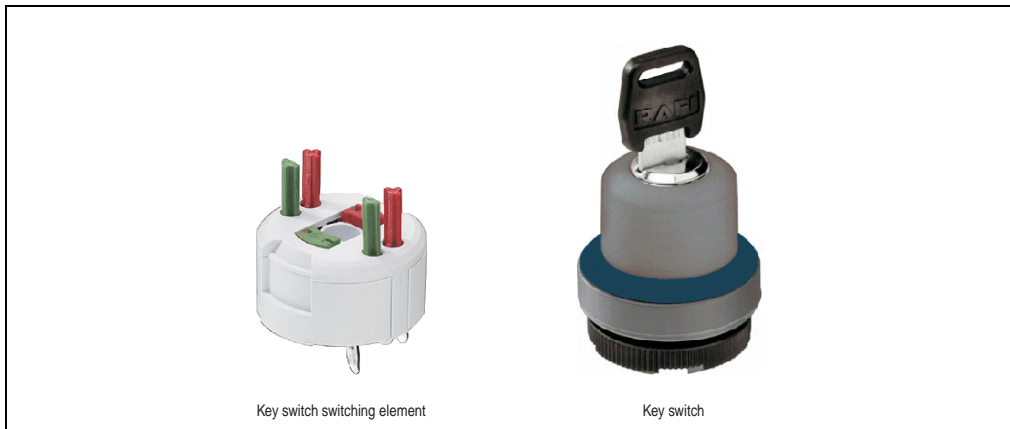

Figure 77: Key switch unit

Information:

The following characteristics, features and limit values are only valid for these individual components and can deviate from those for the entire device. For the entire device where, for example, these individual components are used, the data given for the entire device is valid.

Property	Key switch switching element	Key switch
Manufacturer Type	RAFI 22FS universal switching element, 1 S	RAFI 22FS key switch, round collar
Operating Voltage AC/DC	Max. 42 V	-
Operating Current AC/DC	Max. 100 mA	-
Contact System	Self-cleaning bridge contact	-
Standards		
Normally Open Contact	-	-
Weathering Resistance	-	According to IEC 68-1-2, 2-2 and 2-30
Salt Mist	-	According to IEC 68-2-11
Protection (front side)	-	IP65
Approbations	-	IEC 947, 1058; UL 508; CSA 22.2; EU-NSR 73/23; ULc
Impact Resistance	At least 100 N	
Rotation Angle	1 x 40 degrees, momentary	
Lifespan	1 million actuations at 10 mA/24 VDC	0.3 million, momentary
Environmental Temperature		
Operation	-25 °C to +70 °C	
Storage	-40 °C to +80 °C	
Transport	-40 °C to +80 °C	

Table 75: Technical data for key switch switching element and key switch

3. Enable Switch

The enable switch is a part of the enabling equipment and is integrated in the enable switch cover.

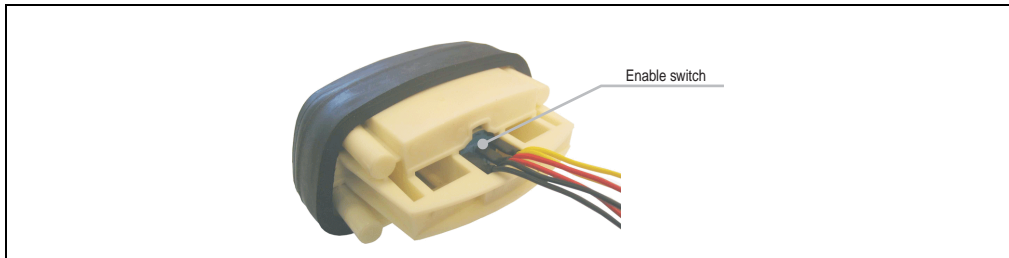

Figure 78: Enable switch

Information:

The following characteristics, features and limit values are only valid for these individual components and can deviate from those for the entire device. For the entire device where, for example, these individual components are used, the data given for the entire device is valid.

Touch Screen

Property	Enable switch
Manufacturer Type	idec HE5B-M2
Environmental Temperature	
Operation	-25 °C to +60° C
Storage	-40 °C to +80 °C
Transport	-40 °C to +80 °C
Humidity	
Operation	45% to 85% (non-condensing)
Altitude	Max. 2000 meters
Operating Voltage AC/DC	Max. 125 V
Operating Current	
AC	Max. 0.5 A at 125 V resistive load Max. 0.3 A inductive load
DC	Max. 1 A at 30 V resistive load Max. 0.7 A inductive load
Minimum Operating Requirements	3 V AC/DC, 5 mA
Insulation Resistance	100 MOhm
Vibration	
Operation	5 to 55 Hz, 0.5 mm amplitude
Shock	
Operation	Max. 100 m/s ²
Impact Resistance	At least 250 N
Lifespan	
Mechanical	Position ¹⁾ 0 -> 1 -> 0: At least 1 million operations
Electrical	Position ¹⁾ 0 -> 1 -> 2 -> 0: At least 100000 operations
Standards	IP65 protection according to IEC60529 IEC60947-5-1 EN60947-5-1 JIS C8201-5-1 UL508 CSA C22.2 No. 14 ISO12100/EN292 IEC60204-1/EN60204-1 ISO11161/prEN11161 ISO10218/EN775 ANSI/RIA R15.06, B11.19

Table 76: Technical data for enable switch

1) For switch positions, see table 23 "Switch positions for the enable switch" on page 61.

4. Touch Screen

4.1 3M Touch

This touch screen is used in 8.4" Mobile Panel designs.

Information:

The following characteristics, features and limit values are only valid for these individual components and can deviate from those for the entire device. For the entire device where, for example, these individual components are used, the data given for the entire device is valid.

3M Touch	Specifications
Manufacturer	3M (www.3M.com)
Precision	-
Reaction Time	-
Release Pressure	10 to 80 grams
Resolution	-
Light Permeability	Up to 85 %
Temperature Operation	- 20 °C to + 50 °C
Storage	- 40 °C to + 70 °C
Transport	- 40 °C to + 70 °C
Waterproofing	-
Lifespan	35 million contacts on the same point
Chemical Resistance ¹⁾	Tea, coffee, ketchup, mustard, vinegar, beer, cola, red wine, cooking oil, whisky, universal cleaning agents, washing detergent, bleach (5.25 %), hydrogen peroxide (3 %), Lysol, ethyl, alcohol, isopropyl alcohol, acetone, methyl ethyl ketone (MEK), toluene, concentrated hydrochloric acid, naphtha, mineral oil, motor oil, diesel, gear fluid, brake fluid, antifreeze, hydraulic oil
Activation	Finger, pointer, credit card, glove

Table 77: 3M Touch

1) The active area of the touch screen is resistant to these chemicals for a timeframe of one hour at 22 °C and 45 % relative humidity.

4.1.1 Cleaning

The touch screen should be cleaned with a moist lint-free cloth. When moistening the cloth, use only water with detergent, screen cleaning agent or alcohol (ethanol). The cleaning agent should be applied to the cloth beforehand and not sprayed directly onto the touch screen itself. Never use aggressive solvents, chemicals or scouring agents.

4.2 Gunze Touch

This touch screen is used in 5.7" Mobile Panel designs.

Information:

The following characteristics, features and limit values are only valid for these individual components and can deviate from those for the entire device. For the entire device where, for example, these individual components are used, the data given for the entire device is valid.

Gunze Touch	Specifications
Manufacturer	Gunze (www.gunzeusa.com)
Precision	-
Reaction Time	-
Release Pressure	< 50 grams (with finger)
Resolution	-
Light Permeability	Up to 84 %
Temperature	
Operation	- 10 °C to + 60 °C
Storage	- 20 °C to + 70 °C
Transport	- 20 °C to + 70 °C
Waterproofing	-
Lifespan	1 million contacts on the same point
Chemical Resistance	Alcoholic-based compound, such as ethanol.
Activation	Finger, pointer, credit card, glove

Table 78: Gunze Touch

4.2.1 Cleaning

The touch screen should be cleaned with a moist lint-free cloth. When moistening the cloth, use only water with detergent, screen cleaning agent or alcohol (ethanol). The cleaning agent should be applied to the cloth beforehand and not sprayed directly onto the touch screen itself. Never use aggressive solvents, chemicals or scouring agents.

5. Mylar

Information:

The following characteristics, features and limit values are only valid for these individual components and can deviate from those for the entire device. For the entire device where, for example, these individual components are used, the data given for the entire device is valid.

The mylar conforms to DIN 42115 (section 2). This means it is resistant to exposure to the following chemicals for a 24 hour period with no visible signs of damage:

Alcohol Cyclohexanol Diacetone alcohol Glycol Isopropanol Glycerin Methanol Triacetin Dowandol DRM/PM	Formaldehyde 37% -42% Acetaldehyde Aliphatic hydrocarbons Toluene Xylene White spirits	1.1.1.Trichloroethane Ethyl acetate Diethyl ether N-Butyl acetate Amyl acetate Butylcellosolve Ether
Acetone Methyl ethyl ketone Dioxan Cyclohexanone MIBK Isophorone	Formic acid<50% Acetic acid<50% Phosphoric acid <30% Hydrochloric acid <36% Nitric acid <10% Trichloroacetic acid <50% Sulphuric acid <10%	Sodium hypochlorite<20% Hydrogen peroxide <25% Potassium carbonate Washing powders Fabric conditioner Ferric chloride Ferrous chloride (FeCl ₂) Ferrous chloride (FeCl ₃) Dibutyl phthalate Diocetyl phthalate Sodium carbonate
Ammonia <40% Caustic soda <40% Potassium hydroxide Alkali carbonate Bichromate Potassium Acetonitrile Sodium bisulphate	Cutting oil Diesel oil Linseed oil Paraffin oil Blown castor oil Silicon oil Turpentine oil substitute Universal brake fluid Aviation fuel Petrol Water Sea water Decon	

Table 79: Chemical resistance of the mylar

The mylar conforms to DIN 42115 section 2 for exposure to glacial acetic acid for less than one hour without visible damage.

6. Filter Glass

If the Mobile Panel is not equipped with a touch screen, then a filter glass with the following properties is used.

Information:

The following characteristics, features and limit values are only valid for these individual components and can deviate from those for the entire device. For the entire device where, for example, these individual components are used, the data given for the entire device is valid.

6.1 Mechanical Characteristics

Abrasion-resistant according to DIN 52347

Adhesive strength according to DIN 58 196-K2 (section 6)

6.2 Chemical Properties

Durability according to DIN 50021 - CASS.

7. Housing

Information:

The following characteristics, features and limit values are only valid for these individual components and can deviate from those for the entire device. For the entire device where, for example, these individual components are used, the data given for the entire device is valid.

The housing surface (paint) is resistant to the following chemicals:

Alcohol Glycol Isopropanol Glycerine Methanol	Vinigar-based cleaning agent Soaps Cleaning agent (such as for auto maintenance or industrial use)	Beer Wine Coffee Fruit
---	---	---------------------------------

Table 80: Chemical resistance of the mylar

Figure 1:	Mobile Panel.....	21
Figure 2:	Mobile Panel device design.....	23
Figure 3:	Dimensions for the entire device.....	24
Figure 4:	Mobile Panel operating unit.....	27
Figure 5:	Operating unit dimensions.....	28
Figure 6:	Example of a Mylar keypad.....	28
Figure 7:	Touch screen pen.....	30
Figure 8:	CF / USB cover.....	30
Figure 9:	Compact Flash and USB slot.....	31
Figure 10:	Inserting a Compact Flash Card.....	33
Figure 11:	Removing a Compact Flash Card.....	34
Figure 12:	Operating unit - rear view.....	35
Figure 13:	Design/dimensions of the serial number label.....	35
Figure 14:	Design/dimensions of the type plate.....	36
Figure 15:	Back of the operating unit - switches, buttons and batteries.....	36
Figure 16:	Inserted lithium battery.....	37
Figure 17:	Front view 4MP181.0843-03.....	39
Figure 18:	Front View 4MP251.0571-12.....	43
Figure 19:	Front view 4MP281.0571-12.....	47
Figure 20:	Front view for 4MP281.0843-13.....	51
Figure 21:	Front View 5MP181.0843-07.....	55
Figure 22:	Operating unit, handle and connection cable.....	59
Figure 23:	Handle 4MPHDL.0000-00.....	59
Figure 24:	Dimensions for the handle.....	60
Figure 25:	Possible enable switch positions.....	61
Figure 26:	Enable switch - position null.....	61
Figure 27:	Enable switch - position enable.....	62
Figure 28:	Enable switch - position panic.....	62
Figure 29:	Fastening/removing the handle to/from the operating unit.....	63
Figure 30:	Fastening the connection cable.....	63
Figure 31:	Connection cable 5CAMPH.0xxx-00.....	64
Figure 32:	Connection cable and handle.....	64
Figure 33:	Connection cable specifications.....	66
Figure 34:	Mobile Panel switching cabinet cable 5CAMPC.0020-00.....	68
Figure 35:	Cable layout for the switching cabinet cable.....	70
Figure 36:	Drilling template for the switching cabinet socket.....	72
Figure 37:	Mobile Panel switching cabinet cable 5CAMPC.0020-01.....	73
Figure 38:	Cable layout for the switching cabinet cable.....	75
Figure 39:	Drilling template for the switching cabinet socket.....	77
Figure 40:	Wall Mount 4MPBRA.0000-00.....	77
Figure 41:	Wall mount 4MPBRA.0000-00 dimensions.....	79
Figure 42:	Cable layout for the strapping plug.....	82
Figure 43:	Pilz PNOZ e1.1p (left) and Pilz PONZ e2.1p (right).....	85
Figure 44:	Connection example for safety circuits up to EN 954-1 Category 4.....	86
Figure 45:	Connection example for safety circuits up to EN 954-1 Category 1.....	88
Figure 46:	Connection example for using in safety circuits up to Category 4 in accordance with EN 954-1 with Pilz PNOZ e2.1p safety relay (with cross connection)	

	detection and simultaneous operation monitoring)	90
Figure 47:	Current load of the enable switch and entry device circuit.....	92
Figure 48:	Control and visualization with the Mobile Panel.....	94
Figure 49:	Operation and monitoring with the Mobile Panel.....	95
Figure 50:	Automation Runtime summary screen	96
Figure 51:	Directions for establishing an ActiveSync connection.....	98
Figure 52:	Mobile Panel as a thin client.....	99
Figure 53:	Risk graph according to EN 954-1, Appendix B.....	119
Figure 54:	Dimensions for Compact Flash card type I	125
Figure 55:	SanDisk White Paper - page 1	126
Figure 56:	SanDisk White Paper - page 2.....	127
Figure 57:	SanDisk White Paper - page 3.....	128
Figure 58:	SanDisk White Paper - page 4.....	129
Figure 59:	SanDisk White Paper - page 5.....	130
Figure 60:	SanDisk White Paper - page 6.....	131
Figure 61:	Taking out the locking screw.....	136
Figure 62:	Removing the attachment cable.....	136
Figure 63:	Removing the enable switch connector.....	137
Figure 64:	Handle clasp screw positions.....	137
Figure 65:	Connecting the attachment cable and handle.....	138
Figure 66:	Connecting the enable switch connector (ST1).....	138
Figure 67:	Connectors and cable arrangement.....	139
Figure 68:	Connecting the handle with the panel	140
Figure 69:	Tightening the cover screw	140
Figure 70:	Taking out the locking screw	141
Figure 71:	Removing the attachment cable.....	142
Figure 72:	Handling the battery	142
Figure 73:	Inserted lithium battery.....	142
Figure 74:	Connecting the handle with the panel	143
Figure 75:	Tightening the cover screw	143
Figure 76:	E-stop unit.....	145
Figure 77:	Key switch unit	146
Figure 78:	Enable switch.....	147

Table 1:	Manual history	11
Table 2:	Safety guidelines	13
Table 3:	Model numbers for Mobile Panel operating unit.....	18
Table 4:	Model number for Mobile Panel handle	18
Table 5:	Model numbers for Mobile Panel connection cables.....	18
Table 6:	Model numbers for Mobile Panel switching cabinet cables.....	19
Table 7:	Model number for Mobile Panel wall mount	19
Table 8:	Model number for Mobile Panel strapping plug.....	19
Table 9:	Model numbers for accessories	20
Table 10:	Model numbers for Mobile Panel software	20
Table 11:	Entire device	25
Table 12:	Technical data for the touch screen pen	30
Table 13:	Technical data for USB port connection.....	31
Table 14:	CF LED	32
Table 15:	Automation Runtime Switch settings for the Mode / Node switch	37
Table 16:	BIOS switch settings for the mode / node switch	37
Table 17:	Technical data for 4MP181.0843-03	39
Table 18:	Technical data for 4MP251.0571-12	43
Table 19:	Technical data 4MP281.0571-12	47
Table 20:	Technical data 4MP281.0843-13	51
Table 21:	Technical data for 5MP181.0843-07	55
Table 22:	Technical data 4MPHDL.0000-00	60
Table 23:	Switch positions for the enable switch	61
Table 24:	Technical data for the Mobile Panel cable 5CAMPH.0xxx-00.....	65
Table 25:	Technical data for the switching cabinet cable 5CAMPC.0020-00.....	69
Table 26:	Technical data for the switching cabinet cable 5CAMPC.0020-01.....	74
Table 27:	Technical data 4MPBRA.0000-00	78
Table 28:	Storing the Mobile Panel device in the wall mount.....	80
Table 29:	Strapping plug order data.....	81
Table 30:	Technical data 4MPBYP.0000-00	81
Table 31:	Current load of the enable switch and entry device circuit	92
Table 32:	Automation Runtime summary screen	96
Table 33:	Overview of standards	101
Table 34:	Overview of limits and testing guidelines for emission	103
Table 35:	Test requirement network related emission industrial area.....	103
Table 36:	: Test requirement electromagnetic emissions industrial area	104
Table 37:	Overview of limits and testing guidelines for immunity	105
Table 38:	Test requirement electrostatic discharge (ESD).....	106
Table 39:	Test requirement high-frequency electromagnetic fields (HF field).....	106
Table 40:	Test requirement high-speed transient electrical disturbances (Burst)	107
Table 41:	Test requirement surge voltages (Surge).....	107
Table 42:	Test requirement conducted disturbances	107
Table 43:	Test requirement magnetic fields with energy technical frequencies.....	108
Table 44:	Test requirement voltage dips, fluctuations and short-term interruptions.....	108
Table 45:	Test requirement damped oscillations	109
Table 46:	Overview of limits and testing guidelines for vibration.....	110
Table 47:	Test requirement vibration operation	110

Table Index

Table 48:	Test requirement vibration transport	110
Table 49:	Test requirement shock operation.....	111
Table 50:	Test requirement shock transport	111
Table 51:	Test requirement toppling	111
Table 52:	Test requirement toppling	112
Table 53:	Overview limit value and test guideline standards temperature and humidity...	112
Table 54:	Test requirement worst case operation	113
Table 55:	Test requirement dry heat	113
Table 56:	Test requirement dry cold	113
Table 57:	Test requirement large temperature fluctuations	113
Table 58:	Test requirement temperature fluctuations in operation.....	114
Table 59:	Test requirement humid heat, cyclical.....	114
Table 60:	Test requirement humid heat, constant (storage)	114
Table 61:	Further Limit Values	114
Table 62:	International Certifications.....	116
Table 63:	Overview of stop function categories	117
Table 64:	Safety category overview	118
Table 65:	Parameters S, F and P lead you to the safety category to be used.....	120
Table 66:	Model numbers for accessories	121
Table 67:	Order data for lithium batteries.....	122
Table 68:	Technical data for lithium batteries	122
Table 69:	Oeder data for the touch screen pen	123
Table 70:	Order data for Compact Flash cards.....	124
Table 71:	Compact Flash cards 5CFCRD.xxxx-02 technical data	124
Table 72:	USB memory stick order data	132
Table 73:	USB memory stick 5MMUSB.0xxx-00 technical data.....	132
Table 74:	Technical data for E-stop switching element and E-stop button	145
Table 75:	Technical data for key switch switching element and key switch.....	147
Table 76:	Technical data for enable switch.....	148
Table 77:	3M Touch	149
Table 78:	Gunze Touch.....	150
Table 79:	Chemical resistance of the mylar	151
Table 80:	Chemical resistance of the mylar	152

A

Accessories	20, 121
Attachment cable	
Exchanging	136

C

Calculating the lifespan	126
Certifications	116
CF / USB cover	30
CF LED	32
Changing the battery	141
Cleaning	135
CMOS battery	122
Change	141
Compact Flash	124
Inserting	33
Removing	34
Technical data	124
Compact Flash Slot	31
Connection cable	18, 64
Cable specifications	66
Technical data	65
Current load	92

D

Device	
Dimensions	24
Operation	84
Technical data	25
Drilling Template	71, 76

E

Enable Switch	
Enable Position	62
Null Position	61
Panic Position	62
Enable switch	60, 147
Connection examples	90
Current load	92
E-stop button	29, 145
Connection examples	86
Current load	92

F

Fastening	62
Features	22
Filter glass	152

H

Handle	18, 59
Dimensions	60
Technical data	60
Housing	152

I

Individual Components	27
Handle	59
Operating unit	27
Individual components	
Connection cable	64
Strapping plug	81
Switching cabinet cable - straight through .	73
Switching cabinet cable crossover	68
Wall Mount	77
Intended use	83

K

Key Switch	146
Key switch	29
Connection examples	86
Current load	92

M

Manual History	11
Model Numbers	18
Monitoring device	85
Mylar	150

O

Operating unit	27
Dimensions	28
Entry Devices	29

Index

Mylar keypad	28	Cable specifications	70, 75
Rear View	35	Drilling Template	71, 76
		Technical data	69, 74
R		System keys	29
Risk Evaluation	119	T	
S		Touch Screen	148
Safety guidelines		Touch screen pen	30
Design	13	Type Plate	36
Safety regulations	13	U	
Enable switch	16	USB	30
E-stop system	16	USB Memory Stick	132
Installation	14	General information	132
Intended Use	14	Order data	132
Introduction	13	Technical data	132
Operation	15	W	
Supply Voltage	15	Wall Mount	19, 77
Transport and Storage	14	Dimensions	79
Serial Number Label	35	Technical data	78
Shielding	68, 73	Windows CE	97
Softkeys	29	General information	97
Software	20	Windows XP Embedded	100
Standards	101	General information	100
Strapping plug	19, 81		
Structure	23		
Switching cabinet cable	19, 68, 73		

0

0AC201.9..... 20, 122

4

4A0006.00-000 20, 122
 4MP181.0843-03 18, 39
 4MP251.0571-12 18, 43
 4MP281.0571-12 18, 47
 4MP281.0843-13 18, 51
 4MPBRA.0000-00..... 19, 77
 4MPBYP.0000-00 19, 81
 4MPHDL.0000-00 18, 59

5

5AC900.1100-00..... 20, 123
 5CAMPC.0020-00..... 19, 68
 5CAMPC.0020-01..... 19, 73
 5CAMPH.0050-00..... 18, 64
 5CAMPH.0070-00..... 18, 64

5CAMPH.0100-00 18, 64
 5CAMPH.0150-00 19, 64
 5CAMPH.0200-00 19, 64
 5CFCRD.0032-02..... 20, 124
 5CFCRD.0064-02..... 20, 124
 5CFCRD.0128-02..... 20, 124
 5CFCRD.0256-02..... 20, 124
 5CFCRD.0512-02..... 20, 124
 5CFCRD.1024-02..... 20, 124
 5CFCRD.2048-02..... 20, 124
 5MMUSB.0128-00 20, 132
 5MMUSB.0256-00 20, 132
 5MMUSB.0512-00 20, 132
 5MP181.0843-07 18, 55

9

9S0001.13-010 20, 97
 9S0001.13-020 20, 97
 9S0001.17-020 20, 97
 9S0001.21-020 20, 100

